

Model/s  
ECD80W

Version  
V1.0 0423

Everything you need  
for your 8kg Condenser  
Clothes Dryer is in this  
User Manual

**esatto**

**esatto**  
everything  
you need

# Contents

---

**Page 5**  
**Welcome**

---

**Page 6**  
**Safety Warnings**

---

**Page 8**  
**Your Dryer**

---

**Page 9**  
**Installation**

---

**Page 10**  
**Control Panel**

---

**Page 11**  
**Operating  
Instructions**

---

**Page 15**  
**Cleaning &  
Maintenance**

---

**Page 17**  
**Technical  
Specifications**

---

**Page 18**  
**Troubleshooting**

---

**Page 20**  
**Purchase Details**

---

**Page 21**  
**Your Receipt**

---

**Page 22**  
**Warranty  
Information**

THIS PAGE HAS BEEN LEFT  
INTENTIONALLY BLANK

# Welcome

**Residentia Group**

—

**Head Office**

165 Barkly Avenue  
Burnley, Victoria  
Australia 3121

—

**ACN**

600 546 656

—

**Online**

residentia.group  
www.esatto.house  
f @esatto.house

—

**Postage**

PO Box 5177  
Burnley, Victoria  
Australia 3121

—

**Telephone**

1300 11 4357

Congratulations on purchasing your new Esatto appliance. The Esatto brand is proudly distributed within Australia by Residentia Group Pty Ltd.

Please refer to the warranty card at the rear of this manual for information regarding your product's parts and labour warranty, or visit us online at: [www.residentia.group](http://www.residentia.group)

At Residentia Group, we are customer obsessed and our Support Team are there to ensure you get the most out of your appliance. Should you want to learn more about your clothes dryer such as the various drying modes or importantly taking care of the appliance, our Support Team are here to help.

You can use our online Support Centre at anytime by visiting:  
<http://support.residentiagroup.com.au>

Or you can contact us via phone by dialing: 1300 11 HELP (4357).

It is important that you read through the following use and care manual thoroughly to familiarise yourself with the installation and operation requirements of your appliance to ensure optimum performance.

Again, thank you for choosing an esatto appliance and we look forward to being of service to you.













Kind Regards,  
The Residentia Team



# Safety Instructions

## DRYER CARE SYMBOLS

Please pay attention to use the drying machine if the materials of your clothes can not be dried by it or contain the symbols as follows:

 Dry	 Normal	 Not tumble dry normal	 Do not dry
 Line dry / hang to dry	 Drip dry	 Dry flat	 In the shade
 Dry clean	 Do not dry clean	 Dry clean normal cycle with any solvent	 Dry clean normal cycle petroleum solvent only

## IMPORTANT!

### CAUTION: RISK OF FIRE!

To prevent any damages to your and others' life or property, you have to follow the safety notes.

- This product belongs to the category of electrical appliances, and only for drying textiles which have been washed with water in the household. Please pay attention to the safety of power use during the operation!
- The power source with reliable earthing must be used. Its earth wire must be buried under the ground and shall not be connected with the public utilities such as city water pipe or gas pipe etc. The earth wire and null wire shall be distinguished and shall not be connected together.
- The maximum mass of dry textile material is 8 kilograms to be used in the appliance.
- That the tumble dryer is not to be used if industrial chemicals have been used for cleaning.
- Do not dry unwashed items in the tumble dryer.
- Adequate ventilation has to be provided to avoid the back flow of gases into the room from appliance burning other fuels, including open fires
- **WARNING:** never stop a tumble dryer before the end of the drying cycle unless all items are quickly removed and spread out so that the heat is dissipated.
- The exhaust air must not be discharged into a flue which is used for exhausting fumes from appliance burning gas or other fuels.
- The appliance must not be install behind a lockable door, a sliding door or a door with a hinge on the opposite side to that of the tumble dryer. In such a way that a full opening of the tumble dryer door is restricted.
- Keep pets away from this appliance.
- Oil-affected items can ignite spontaneously, especially when exposed to heat sources such as in a tumble dryer. The items become warm, causing an oxidation reaction in the oil. Oxidation creates heat. If the heat cannot

escape, the items can become hot enough to catch fire. Piling, stacking or storing oil-affected items can prevent heat from escaping and so create a fire hazard.

- If it is unavoidable that fabrics that contain vegetable or cooking oil or have been contaminated by hair care products be placed in a tumble dryer they should first be washed in hot water with extra detergent-this will reduce, but not eliminate, the hazard.
- The appliance should not be overturned during normal use or maintenance.
- If the power cable is damaged, it must be replaced by the manufacturer, its service agent or similarly qualified persons in order to avoid a hazard.
- This appliance is for indoor use only.
- The openings must not be obstructed by a carpet.
- Children of less than 3 years should be kept away unless continuously supervised. If the appliance appear high temperature abnormally, please draw the mail plug immediately.
- The appliance is not intended for use by persons (including children) with reduced physical, sensory or mental capabilities, or lack of experience and knowledge, unless they have been given supervision or instruction concerning use of the appliance by a person responsible for their safety. Children should be supervised to ensure that they do not play with the appliance.
- Always close the door after use. In this way you will avoid the danger of children and pets (or small animals) climbing onto or into the dryer or hiding things in it.

To ensure your and your family's safety, please make improvement immediately if any power use at your home does not meet the above-mentioned requirement.

### ELECTRIC SHOCK HAZARD

- The appliance corresponds to protection class I and may only be connected to a plug with a protective conductor that has been installed properly. When connecting the appliance to the mains, make sure that the mains voltage is correct. You can find more information about this on the rating plate.
- The electrical safety of this tumble dryer can only be guaranteed when correctly earthed. It is essential that this standard safety requirement is met. If in any doubt, please have the household wiring system tested by a qualified electrician. The manufacturer cannot be held liable for the consequences of an inadequate earthing system (e.g. electric shock).
- Before connecting the tumble dryer, ensure that the connection parameter on the rating plate (fuse rating, voltage and frequency) match the mains electricity supply. If in any doubt, consult a qualified electrician.
- The electrical safety of this tumble dryer can only be guaranteed when correctly earthed. It is essential that this standard safety requirement is met. If in any doubt, please have the household wiring system tested by a

qualified electrician. The manufacturer cannot be held liable for the consequences of an inadequate earthing system (e.g. electric shock).

- Do not pull the power cord forcefully. Please grasp the mains plug instead
- Do not draw the power cord forcefully to pull out the mains plug.
- Do not bend, clamp or damage the power cord and the power plug.
- If the power cable is damaged, it must be replaced by the manufacturer, its service agent or similarly qualified persons in order to avoid a hazard.
- Please do not plug/draw the mains plug with wet hands.
- Warning: The appliance must not be supplied through an external switching device, such as a timer, or connected to a circuit that is regularly switched on and off by a utility.
- Do not connect the appliance to the mains electricity supply by an extension lead, multi-socket adapter or similar.
- The accessibility of the plug must always be ensured, in order to disconnect the tumble dryer from the mains.
- If the appliance appear high temperature abnormally, please draw the mail plug immediately.

#### **INJURY DANGER**

- The appliance must not be installed behind a lockable door, a sliding door or a door with a hinge on the opposite side to that of the tumble dryer, in such a way that a full opening of the tumble dryer door is restricted.
- Do not disassemble and install the dryer under no instruction or supervision.
- Do not stack this dryer on washing machine without stacking kits. If want stacking on washing machine, please purchase the Independent parts and it must be installed by the manufacturer, its service agent or similarly qualified persons in order to avoid a hazard.
- Do not lean on the opened door of the dryer.
- Do not put any objects on the dryer, such as a candle or electric cooker.
- Condensed water is not drinking water. It can cause health problems in both people and animals if consumed.

#### **DAMAGE DANGER**

- Do not dry over the rated capacity.
- Do not operate the dryer without the lint filter.
- Do not dry the clothes before being spun.
- Do not expose the dryer directly under the sun, and indoor use only.
- Do not install the dryer in the humid and wet/drenching environment.
- During cleaning and maintenance, please do remember to pull out the power plug and do not directly wash the dryer with water.

#### **EXPLOSION & FIRE DANGER**

- Please do not dry the clothes with some flammable substances such as the coal oil, alcohol or there will be the explosion.
- The tumble dryer is not to be used if industrial chemicals have been used for cleaning.
- Do not dry unwashed items in the tumble dryer.
- Items that have been soiled with substances such as cooking oil, acetone, alcohol, petrol, kerosene, spot removers, turpentine, waxes and wax removers should be washed in hot water with an extra amount of detergent before being dried in the tumble dryer.
- Items such as foam rubber (latex foam), shower caps, waterproof textiles, rubber backed articles and clothes or pillows fitted with foam rubber pads should not be dried in the tumble dryer.
- The final part of a tumble dryer cycle occurs without heat (cool down cycle) to ensure that the items are left at a temperature that ensures that the items will not be damaged.
- Oil-affected items can ignite spontaneously, especially when exposed to heat sources such as in a tumble dryer.
- The items become warm, causing an oxidation reaction in the oil. Oxidation creates heat. If the heat cannot escape, the items can become hot enough to catch fire. Piling, stacking or storing oil-affected items can prevent heat from escaping and so create a fire hazard.
- Remove all objects from pockets such as lighters and matches.
- If it is unavoidable that fabrics that contain vegetable or cooking oil or have been contaminated by hair care products be placed in a tumble dryer they should first be washed in hot water with extra detergent. This will reduce, but not eliminate, the hazard.
- **WARNING:** Never stop a tumble dryer before the end of the drying cycle unless all items are quickly removed and spread out so that the heat is dissipated.
- Openings must not be obstructed.
- The lint filter has to be cleaned frequently and lint must not to be allowed to accumulate around the dryer.

#### **DISPOSAL OF PACKAGING**

- The packaging is designed to protect the appliance from damage during transportation. The packaging materials are environmentally friendly and should be recycled. Recycling the packaging can reduce the use of raw materials in the manufacturing process and the amount of waste in landfill sites.

# Your Dryer

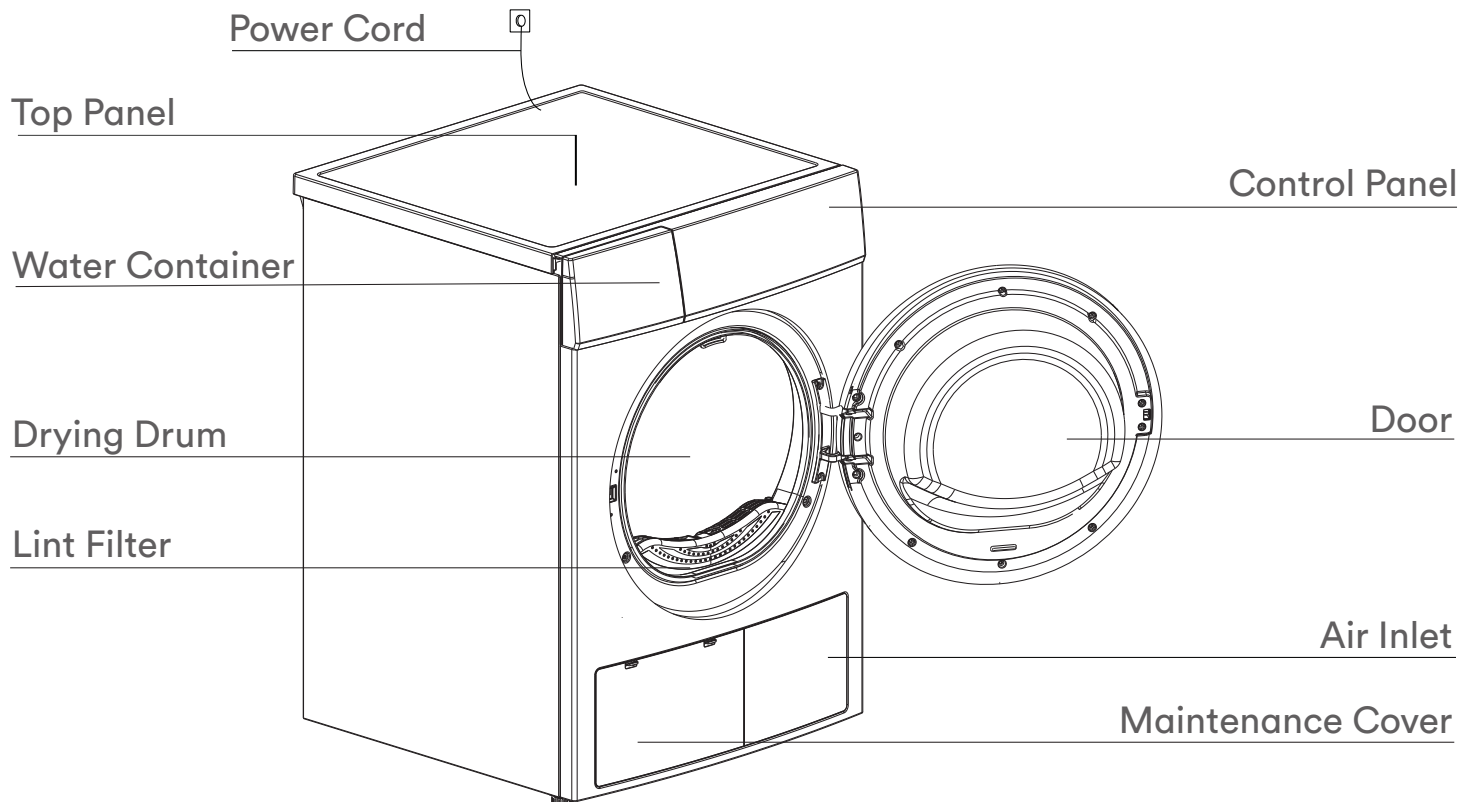

**NOTE!**

The images in this user manual are for reference only. Your appliance may appear differently.

**ACCESSORIES**

The following parts are necessary if you wish to use the drain hose to drain the water externally. Please follow the instructions below to do this.

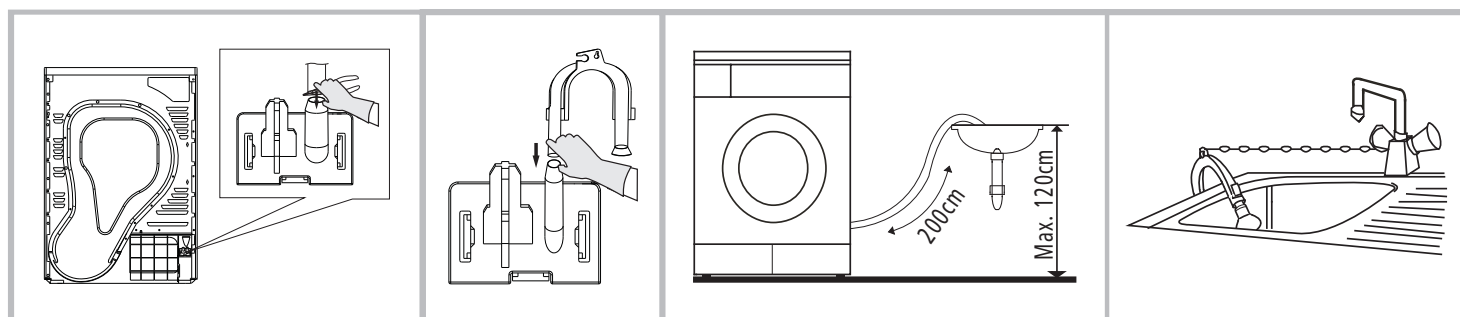
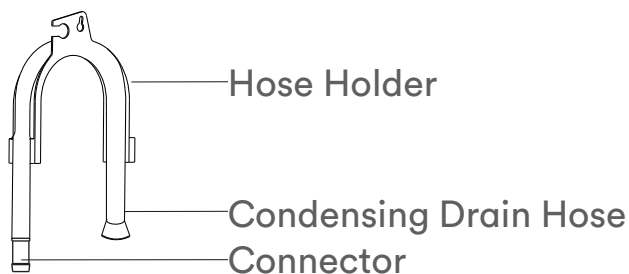

1. Use a pair of pliers to remove the drain hose from the hose connector

2. Insert the external drainage hose

3. Put the hose holder in the washing basin or any other sink. Be careful not to bend the external drain hose.



# Installation

## IMPORTANT!

If the power cord is damaged, it must be replaced by Residentia Group or one of its authorised service representatives. Please contact 1300 11 HELP (4357) and ensure the appliance is completely disconnected from the power supply.

## TRANSPORT

Move cautiously. Do not grasp any salient parts of machine. The machine door cannot be used as the handle for transport.

Risk of injury and damage! Improper handling of the appliance may result in injury.

- The appliance is very heavy. Never transport or carry the appliance alone; always with the assistance of another person.
- Remove all obstacles on the transport route and from the installation location, e.g. open doors and clear away objects lying on the floor.
- Do not use the open door as a handhold.
- Remove all package material before using the appliance.
- Before setting up the tumble dryer, check it for any externally visible damage. Do not install or use a damaged tumble dryer.
- Do not install the tumble dryer in a room where there is a risk of frost occurring. At temperatures around freezing point the tumble dryer may not be able to operate properly. There is a risk of damage if the condensed water is allowed to freeze in the pump and hoses.

## INSTALLATION POSITIONING

- Children can become entangled in the packaging film or swallow small parts and suffocate. Do not allow children to play with the packaging.
  - The appliance must not be installed behind a lockable door, a sliding door or a door with a hinge on the opposite side to that of the tumble dryer, in such a way that a full opening of the tumble dryer door is restricted.
  - Do not restrict the floor clearance through deep pile carpets, strips of wood or similar. This might cause heat built-up which would interfere with the operation of the appliance.
1. It is recommended that, for your convenience, the machine is positioned close to your washing machine.
  2. Do not stack this dryer on washing machine without stacking kits. (If you want to stack this dryer on a washing machine, please purchase the independent parts. Installation shall be done by the manufacturer, its service agent or similarly qualified persons to avoid any hazards.)
  3. The tumble dryer must be installed in a clean place, where dirt does not accumulate. Air must be able to circulate freely around the appliance. Do not obstruct the front air inlet or the air intake grilles at the back of the machine.
  4. To keep vibration and noise within minimum level when the dryer is in use, it must be placed on a firm and level surface.
  5. The feet must never be removed.

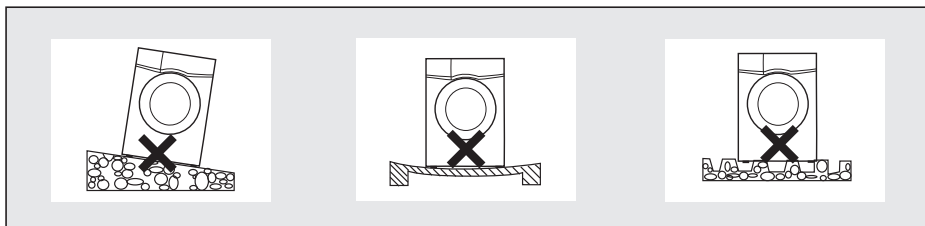

## LEVEL ADJUSTING

Once in its permanent operating position, check that the dryer is absolutely level with the aid of a spirit level. If it is not, adjust the feet by hand or using a tool.

## POWER SUPPLY CONNECTION

1. Make sure that the voltage of the power supply is the same as the electric specification.
2. Do not connect the dryer with the power connection board, a universal plug or socket, do not use multi-plug adapters and extension cables.

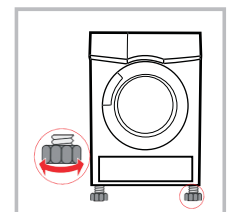

# Control Panel

## YOUR CONTROL PANEL

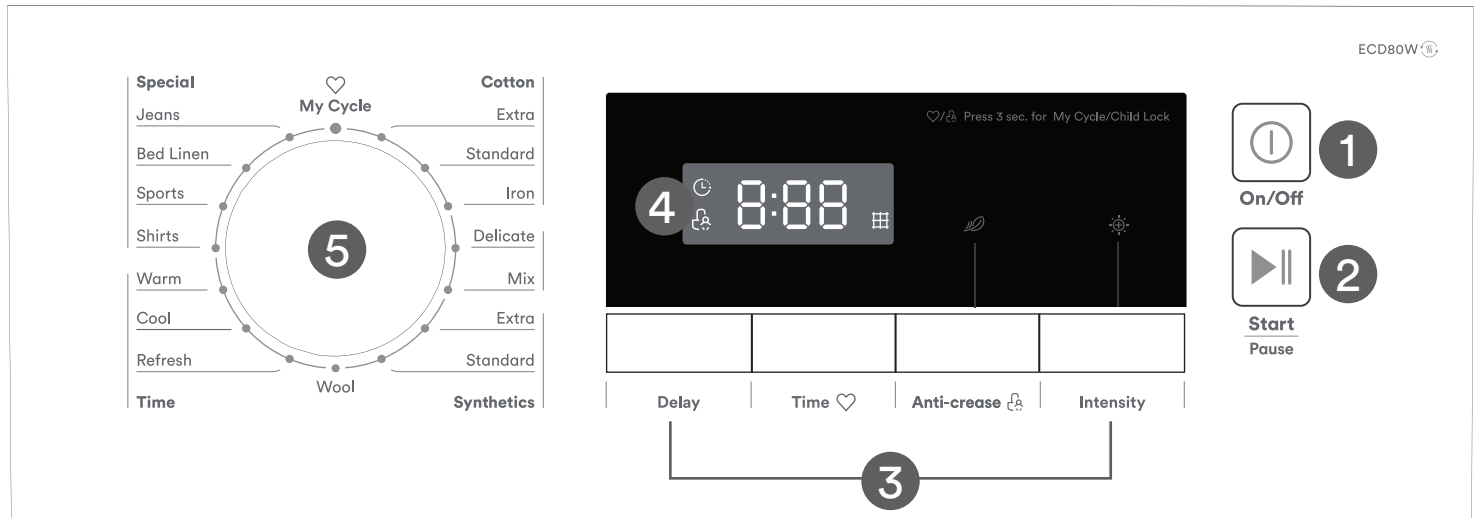

1. On/Off
2. Start/Pause
3. Additional Function Buttons
4. LED Display Screen
5. Program control dial

## DISPLAY SCREEN SYMBOLS

	Delay
	Child Lock
	Anti-crease
	My Cycle
	Time Remaining Indicator /Error Message
	Clean Filter (Warning)
	Empty Water Container (Warning)
	Intensity

# Operating Instructions

## BEFORE FIRST USE

Before first use, please use some soft fabric to clean the inside drum.











1. Put some clean rags into the drum
2. Plug the power, press *On/Off*
3. Select the *Refresh Program*, press *Start/Pause* button
4. After finishing this program, please refer to the "Maintenance and Cleaning" section to clean the door filter.

Note: During drying, the compressor and the water will generate some noise which is completely normal.

## BEFORE DRYING

1. Before drying, thoroughly spin the laundry in washing machine. High spin speed shortens the drying time and saves energy.
2. For uniform drying result, sort the laundry according to fabric type and select the appropriate drying program.
3. Before drying, please close zips, hooks and eyelets, button, tie fabric belts, etc.
4. Remove all objects from pockets such as lighters and matches.
5. Sew in or remove under wiring from bras.
6. Close duvet covers and pillow cases to prevent small items from being rolled up inside them.
7. Leave jackets open and undo any long zips so that textiles dry evenly.
8. Do not over dry the clothes, because over dried clothes can easily get creases.
9. Do not dry the articles containing rubber or similar elastic materials.
10. Keep the area around the tumble dryer clean. Coal dust or flour may cause an explosion.
11. The door shall be opened only after the program of the tumble dryer is finished to avoid being scalded by hot steam or over heated drying machine.
12. Clean the lint filter and empty water container after each use to avoid extension of drying time and increase of energy consumption.
13. Do not dry clothes after dry-clean process.

## APPROXIMATE WEIGHTS OF DRY CLOTHES

 Sweater (mixed 800g)	 Jacket (cotton 800g)	 Jeans (800g)	 Bath Towel (cotton 900g)
 Single bedsheet (cotton 600g)	 Work clothes (1120g)	 Pyjamas (200g)	 Shirt (cotton 300g)
 T-Shirt (cotton 180g)	 Underwear (cotton 70g)	 Socks (mixed-weave 50g)	

Note: Do not put more clothing in the dryer than the rated capacity.  
Do not dry dripping wet laundry, it may damage the laundry.

Only dry laundry suitable for tumble drying. Regard the laundry care labels:

- Suitable for tumble drying
- Normal drying process: Drying in the tumbler is possible under normal load and temperature 80°C.
- Mild drying process: Caution is appropriate when tumble drying.  
Select mild process with reduced thermal action.
- Do not tumble dry: Articles unsuitable for drying in the tumbler.

# Operating Instructions (Continued)

## QUICK START

### CAUTION!

- Prior to using the dryer, ensure that it is correctly installed.

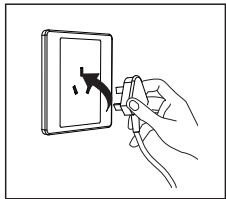

Plug in

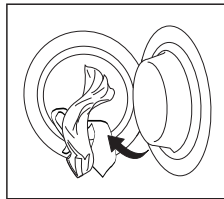

Load laundry

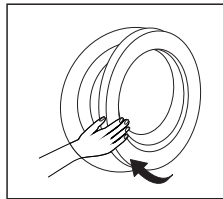

Close the door

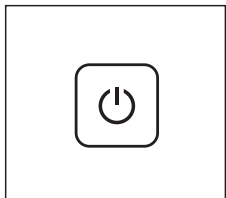

Press On

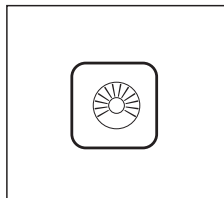

Select desired program

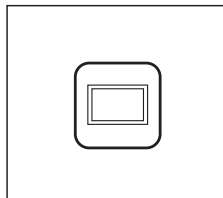

Select any desired additional programs

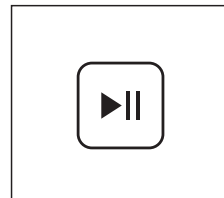

Press Start

## AFTER DRYING

The appliance will sound an alert and the display will show "00:00" after the drying cycle is complete.

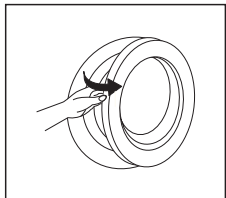

Open the door and take out the laundry

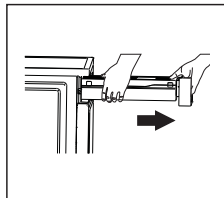

Pull out the container

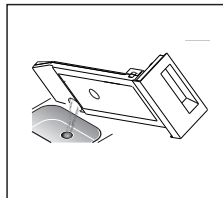

Pour out the condensate water

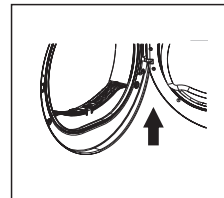

Clean the filter

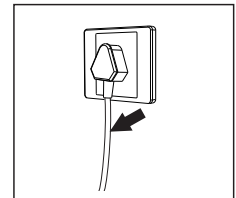

Power off

### NOTE!

The images in this user manual are for reference only. Your appliance may appear differently.

## DRYING START

The drum will rotate after the program starts. The cycle phase LED in the display will light up and the remaining program time will be displayed.

## DRYING END

1. The drum will stop rotating after the program ends. The display will show "0:00", also the cycle phase LED showing "End" and related LED will illuminate. The dryer will start Anti-Crease function if user doesn't remove the load.
2. Please press *On/Off* button after unloading the tumble dryer to cut off power and pull out the plug.

## USING THE ADDITIONAL FUNCTIONS

### DELAY FUNCTION

This function is used for delaying the start of the drying program up to 24 hours. When the delayed program starts, the time starts to countdown on the display and the delay icon blinks.

1. Load your laundry and make sure the machine door is closed.
2. Press the **On/Off** button, then use the program selector knob to select the desired program.
3. You can additionally select the **Anti-Crease** function according to your need.
4. Press the **Delay** button.
5. Repeatedly press the **Delay** button to select the desired delay time.
6. Then press the **Start/Pause** button and the dryer will be in standby and the delay time will start counting down. The drying procedure will be automatically performed when the delay time is over.
7. If you press the **Start/Pause** button again, the delay function will be paused.
8. If you want to cancel the "Delay" function, please press the **On/Off** button.

### TIME

When the **Time** program is selected, the **Time** button can be used to adjust the drying time in 10 minute increments.

### ANTI-CREASE FUNCTION

At the end of the drying cycle, the anti-crease operation time is automatically set to 30 minutes or 120 minutes if you select it. Press the **Anti-crease** button to select the time. If you do not want to use this function simply remove your laundry at the end of the cycle.

This function prevents the laundry from creases. The laundry can be removed during the anti-crease phase. Except Cool, Wool and Refresh, all the other programs have this function.

### INTENSITY

You can adjust the dryness level of the laundry by pressing the **Intensity** button.

1. The intensity function can be activated only before the program starts.
2. Except the Cotton Iron, Delicate, Wool, Refresh, Cool and Warm programs, all the other programs can be adjusted with the Intensity function.

### MY CYCLE

Used to define and save your favourite program, so you can use it frequently with the press of a button.

1. Select the desired program and other drying functions.
2. Press and hold the **Time** for 3 seconds until the beep sounds and the desired program settings have been saved.
3. Next time you dry, turn the program selector to the **My Cycle** position, then you can start your favourite program. If you want to change the **My Cycle** settings, repeat the steps (1) and (2).

### CHILD LOCK

This machine incorporates a special child safety lock, which can prevent children from carelessly pressing buttons and doing damage to themselves or the appliance.

1. When the drying cycle is running, press the **Anti-Crease** button for 3 seconds to activate the child lock function.
2. When child lock function is set, the display will show Child lock icon and all buttons are deactivated, except the **On/Off** button.
3. To deactivate the child lock function, press the **Anti-Crease** button for 3 seconds.

# Operating Instructions (Continued)

## DRYING PROGRAMS TABLE

PROGRAM		MAX LOAD	RECOMMENDED USE/ PROPERTIES	DELAY	TIME
Cotton	Extra	8.0kg	For single or multi layered cotton laundry to be dried completely for immediate storage.	Y	N
	Standard				
	Iron		For single layered cotton laundry to remain damp for ironing.		
Delicate	-	1.0kg	For delicate laundry that is suitable for drying or laundry advised to be hand washed at a low temperature.	Y	N
Mix	-	3.5kg	For mixed fabrics from cotton and synthetics.	Y	N
Synthetics	Extra	3.5kg	For thick or multi-layer synthetic fabrics to be dried completely	Y	N
	Standard		To dry thin synthetic textiles, which are not ironed, such as easy care shirts, baby cloths or socks.		
Wool	-	1.0kg	To refresh you wool items and make them more fresh and fluffy.	Y	N
Special	Jeans	6.0kg	To dry jeans or denim clothes that are spun at high speed in the washing machine.	Y	N
	Bed Linen	4.0kg	To dry bed linen, bed sheets or other large items.		
	Sports	3.0kg	To dry sportswear and thin fabrics from polyester, which are not ironed.		
	Shirts	3.0kg	For easy care laundry such as shirts and blouses equipped with anti-crease functionality to minimise the ironing effort. Place clothes loosely in the dryer. Once dried, remove quickly and hang it on a clothes hanger.		
My Cycle	-	-	Define and save your favourite program settings.	Y	-
Time	Warm	-	To dry individual items or complete the drying process of multi-layer fabrics with different drying behaviour, such as jackets, pillows or voluminous items. Min. 10 minutes — Max. 120 minutes.	Y	Y
	Cool	-	To air items without heating. Min. 10 minutes — Max. 30 minutes.		
	Refresh	1.0kg	To refresh clothes kept at closed environment for a long time or to remove odors. Min. 20 minutes — Max. 150 minutes.		

### Note:

- Test programme in accordance with Regulation 392/2012/EU for energy labelling, measured in accordance with EN 61121 and suitable for drying normal cotton load at rated load capacity.
- Thick or multi-layered fabrics, e.g. bedlinen, jeans, jackets etc, are not easy to dry. We recommend the Cotton Extra programme for these instances.
- As the uneven material, thick and multi-layered clothes are not easy to dry, it is better to choose the appropriate time drying programme to dry them if some parts of the clothes still damp after programme finished.
- All data are measured in accordance with SASO-2883. The actual consumption may differ from the values given in the table, depending on the amount of the laundry, type of fabric, residual moisture and any additional functions selected.

MODEL	PROGRAM	MAX LOAD	SPIN SPEED	RESIDUAL HUMIDITY	DELAY
ECD80W	Cotton Standard	8.0kg	1000RPM	60%	168min
	Cotton Standard	4.0kg	1000RPM	60%	97min
	Synthetic Standard	3.5kg	800RPM	40%	57min

# Cleaning & Maintenance

## CLEANING AND CARE

### EMPTYING THE WATER CONTAINER

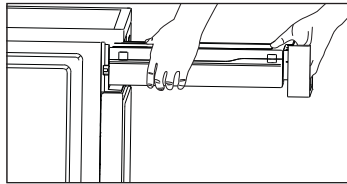

Pull out the water container and keep level with two hands.

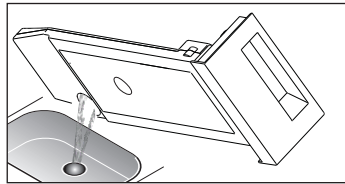

Tilt the water container to pour out condensate into the basin.

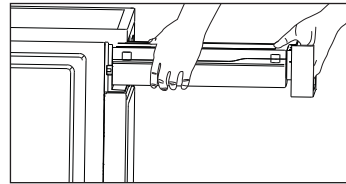

Reinstall the water container once empty.

### WARNING!

Empty the water container after each use. Once the water container is filled completely, the program will be paused and the "FUL" icon will light. After the container is emptied, the dryer can be restarted by pressing *Start/Pause* button.

- Do not drink the condensate water.
- Do not use the dryer without the water container.

### CLEANING THE LINT FILTER

Make sure you clean the door filter after each cycle.

1. Open the door.
2. Take out the lint filter.
3. Open the filter and remove the fluff on the filter. You can use running water to help clean it.
4. Dry the filter door thoroughly before reinstalling it.

Note: Take notice of the correct orientation of the filter before inserting it back.

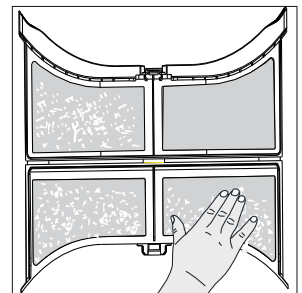
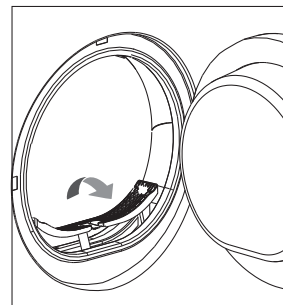

### WARNING!

- The fluff accumulated on the filter will block the air circulation. Not cleaning the filter regularly will increase drying time and energy consumption.
- Disconnect the power cord before cleaning!
- Do not operate the dryer without the filter!

### Note:

- The lint accumulated on the filter will block the air circulation, which will cause the extension of drying time and increase energy consumption. Therefore the lint filter shall be cleaned after each use.
- Take notice of the correct orientation before to insert the lint filter.
- Do not operate the dryer without the lint filter!
- Clean the lint filter after each use to prevent lint accumulation inside the dryer

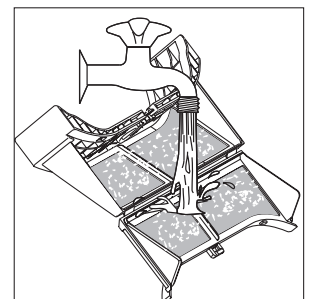

# Cleaning & Maintenance (Continued)

## CLEANING THE HEAT EXCHANGER

**WARNING!** Do not touch the heat exchanger with your hand as it may cause injury. Let the dryer to cool down first.

Residual water may leak out, place an absorbent cloth under the maintenance cover.

- Unlock the maintenance cover.
- Completely open maintenance cover.
- Turn both locking levers towards each other.
- Pull out the heat exchanger.
- Flush the heat exchanger with water to remove lint; let the water drain properly.
- Clean the seals.
- Re-insert the heat exchanger, the handle at the bottom.
- Turn both locking levers.
- Close the maintenance cover until it locks into position.

**WARNING!** Do not damage the heat exchanger!

- Clean the heat exchanger without applying any pressure. Otherwise the heat exchanger could be damaged. The dryer will not dry if the cooling fins are damaged or bent.
- Clean as necessary, approx. once every 3 months, remove the fluff from the heat exchanger using a vacuum cleaner with a dusting brush attached.
- Clean with water only; do not use hard/sharp-edged objects!

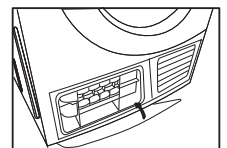
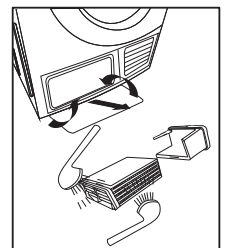
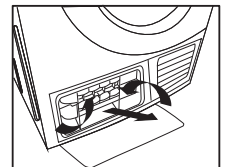
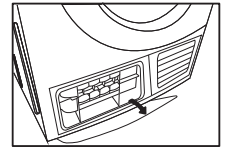

## MAINTENANCE

### WARNING!

- Disconnect the power cord before cleaning.
- Clean the dryer with a clean damp cloth only.
- Do not use solvents, abrasive cleaners, glass cleaners or all-purpose cleaners. These could damage plastic surfaces and other parts.
- Please wear gloves when cleaning.

## CLEANING YOUR DRYER

- Prepare a clean damp cloth using clean water.
- Clean the door, especially the inside window.
- Clean the sealing around the door opening.
- Clean the humidity sensor inside the drum.
- Take out the filter, clean the sealing and air flow openings.
- Before starting the dryer, dry all parts with a soft cloth.



# Technical Specifications

Below outlines the technical specifications for your Esatto Condenser Dryer.

Model	<b>ECD80W</b>
Size	595W × 615D × 845H (mm)
Net Weight	40kg
Rated Input Power	2200W
Ambient temperature	+5°C ~ +35°C
Rated Capacity	8.0kg
Rated Voltage	220–240V~
Rated Frequency	50Hz

Note:

- The rated capacity is the maximum capacity, make sure that the dry clothes which are loaded to the appliance do not exceed the rated capacity.
- Do not install the tumble dryer in a room when there is a risk of frost occurring. At temperatures around freezing point the tumble dryer may not be able to operate properly.
- There is a risk of damage if the condensate water is allowed to freeze in the pump, hoses and / or condensate water container.

# Troubleshooting

## OPERATION IN CASE OF EMERGENCY

In the event of an emergency you should:

- Switch off all controls.
- Switch the washing machine off at the power point or at the fuse box.
- Call the Residentia Support Team on 1300 11 HELP (4357).

Some minor faults can be fixed by referring to the instructions given in the Troubleshooting section below. There is also a self-help section online at <https://support.residentiagroup.com.au/>

DESCRIPTION	SOLUTION
Display is not on	<ul style="list-style-type: none"> <li>• Check if the power supply works.</li> <li>• Check if the mains plug is inserted.</li> <li>• Check the selected program.</li> <li>• Press the On/Off button.</li> </ul>
"FUL" Displays	<ul style="list-style-type: none"> <li>• Check the water container. If it's full, please pour out the condensate water and restart the dryer.</li> <li>• If the container is not full, please restart the dryer.</li> <li>• If the "FUL" icon is still lit after you have finished the first two steps, please contact the after sales service team.</li> </ul>
"  Displays	<ul style="list-style-type: none"> <li>• Clean the lint filter.</li> </ul>
Dyer does not start	<ul style="list-style-type: none"> <li>• Connect the dryer to the mains.</li> <li>• Turn on the tumble dryer.</li> <li>• Check the door is closed.</li> <li>• Check the program is set.</li> <li>• Press the Start/Pause button.</li> </ul>
Degree of dryness was not reached or drying time too long	<ul style="list-style-type: none"> <li>• Clean lint filter.</li> <li>• Empty the water container.</li> <li>• Check the drain hose.</li> <li>• Check installation place is appropriate.</li> <li>• Keep the air inlet clean.</li> <li>• Use higher drying intensity level program or time program.</li> </ul>
The dryer switches off at the end of the program	<ul style="list-style-type: none"> <li>• This is normal operation. The dryer will switch off automatically for energy saving</li> </ul>

**ERROR MESSAGES AND SOLUTIONS****WARNING!** Never dismantle the dryer.

INDICATION	REASON	SOLUTION
"E32" displays	Humidity sensor error.	Please contact the Residentia Group support team on 1300 11 HELP (4357).
"E33" displays	Temperature sensor error.	
"FUL" displays	Water Container is full.	Empty the water container.

**WARNING!**

- Only authorised technicians can carry out repairs.
- If the LED displays other prompt and the dryer does not work, please turn off the machine and call the Residentia Group support team.

# Purchase Details

For future reference, please record the following information which can be found on the rating plate and the date of purchase which can be found on your sales invoice.

---

## STORE DETAILS

---

STORE NAME |

---

ADDRESS |

---

TELEPHONE |

PURCHASE DATE |

---

---

## PRODUCT DETAILS

---

MODEL NO. |

---

SERIAL NO.\* |

---

Attach your receipt  
to this page



# Warranty Information

## AUSTRALIA WARRANTY TERMS & CONDITIONS LAUNDRY APPLIANCES

This document sets out the terms and conditions of the product warranties for Residentia Group Appliances. It is an important document. Please keep it with your proof of purchase documents in a safe place for future reference should you require service for your Appliance.

1. **IN THIS WARRANTY**
  - (a) 'acceptable quality' as referred to in clause 10 of this warranty has the same meaning referred to in the ACL;
  - (b) 'ACL' means Trade Practices Amendment (Australian Consumer Law) Act (No.2) 2010;
  - (c) 'Appliance' means any Residentia Group product purchased by you accompanied by this document;
  - (d) 'ASR' means Residentia Group authorised service representative;
  - (e) 'Residentia Group' means Residentia Group Pty Ltd of 165 Barkly Ave, Burnley VIC 3121, ACN 600 546 656 in respect of Appliances purchased in Australia;
  - (f) 'major failure' as referred to in clause 10 of this warranty has the same meaning referred to in the ACL and includes a situation when an Appliance cannot be repaired or it is uneconomic for Residentia Group, at its discretion, to repair an Appliance during the Warranty Period;
  - (g) 'Warranty Period' means:
    - (i) where the Appliance is used for personal, domestic or household use (i.e. normal single family use) as set out in the instruction manual, the Appliance is warranted against manufacturing defects for 24 months, following the date of original purchase of the Appliance;
  - (h) 'you' means the purchaser of the Appliance not having purchased the Appliance for re-sale, and 'your' has a corresponding meaning.
2. This warranty only applies to Appliances purchased and used in Australia and is in addition to (and does not exclude, restrict, or modify in any way) any non-excludable statutory warranties in Australia.
3. During the Warranty Period Residentia Group or its ASR will, at no extra charge if your Appliance is readily accessible for service, without special equipment and subject to these terms and conditions, repair or replace any parts which it considers to be defective. Residentia Group or its ASR may use remanufactured parts to repair your Appliance. You agree that any replaced Appliances or parts become the property of Residentia Group. This warranty does not apply to light globes, batteries, filters, seals or similar perishable parts.
4. Parts and Appliances not supplied by Residentia Group are not covered by this warranty.

5. You will bear the cost of transportation, travel and delivery of the Appliance to and from Residentia Group or its ASR. If you reside outside of the service area, you will bear the cost of:
  - (a) travel of an authorised representative;
  - (b) transportation and delivery of the Appliance to and from Residentia Group or its ASR, in all instances, unless the Appliance is transported by Residentia Group or its ASR, the Appliance is transported at the owner's cost and risk while in transit to and from Residentia Group or its ASR.
6. Proof of purchase is required before you can make a claim under this warranty.
7. You may not make a claim under this warranty unless the defect claimed is due to faulty or defective parts or workmanship. Residentia Group is not liable in the following situations (which are not exhaustive):
  - (a) the Appliance is damaged by:
    - (i) accident
    - (ii) misuse or abuse, including failure to properly maintain or service
    - (iii) normal wear and tear
    - (iv) power surges, electrical storm damage or incorrect power supply
    - (v) incomplete or improper installation
    - (vi) incorrect, improper or inappropriate operation
    - (vii) insect or vermin infestation
    - (viii) failure to comply with any additional instructions supplied with the Appliance;
  - (b) the Appliance is modified without authority from Residentia Group in writing;
  - (c) the Appliance's serial number or warranty seal has been removed or defaced;
  - (d) the Appliance was serviced or repaired by anyone other than Residentia Group, an authorised repairer or ASR.
8. This warranty, the contract to which it relates and the relationship between you and Residentia Group are governed by the law applicable where the Appliance was purchased.
9. To the extent permitted by law, Residentia Group excludes all warranties and liabilities (other than as contained in this document) including liability for any loss or damage whether direct or indirect arising from your purchase, use or non use of the Appliance.
10. For Appliances and services provided by Residentia Group in Australia, the Appliances come with a guarantee by Residentia Group that cannot be excluded under the Australian Consumer Law. You are entitled to a replacement or refund for a major failure and for compensation for any other reasonably foreseeable loss or damage. You are also entitled to have the Appliance repaired or replaced if the Appliance fails to be of acceptable quality and the failure does not amount to a major failure. The benefits to you given by this warranty are in addition to your other rights and remedies under a law in relation to the Appliances or services to which the warranty relates.
11. At all times during the Warranty Period, Residentia Group shall, at its discretion, determine whether repair, replacement or refund will apply if an Appliance has a valid warranty claim applicable to it.
12. Missing parts are not covered by warranty. Residentia Group reserves the right to assess each request for missing parts in a case by case basis. Any parts that are not reported missing in the first week after purchase will not provide free of charge.
13. To enquire about claiming under this warranty, please follow these steps:
  - (a) carefully check the operating instructions, user manual and the terms of this warranty;
  - (b) have the model and serial number of the Appliance available;
  - (c) have the proof of purchase (e.g. an invoice) available;
  - (d) telephone the numbers shown below.
14. You accept that if you make a warranty claim, Residentia Group and its ASR may exchange information in relation to you to enable Residentia Group to meet its obligations under this warranty.

#### IMPORTANT

Before calling for service, please ensure that the steps in point 13 have been followed.

- Service: Please call 1300 11 HELP (4357)
- Spare parts: Please call 1300 11 SPARE (7727)

---

**The Australian Consumer Law requires the inclusion of the following statement with this warranty:** Our goods come with guarantees that cannot be excluded under the Australian Consumer Law. You are entitled to a replacement or refund for a major failure and for compensation for any other reasonably foreseeable loss or damage. You are also entitled to have the goods repaired or replaced if the goods fail to be of acceptable quality and the failure does not amount to a major failure.

---



E2447

**esatto**  
everything  
you need



A RESIDENTIA  
GROUP INITIATIVE