

Product:

5.5kg Top  
Load Washing  
Machine

Model Code/s:

ETLW55

# Esatto

## User Manual

Exactly what  
you need

Online:

[esatto.house](http://esatto.house)

# Welcome

## **Residentia Group**

—

## **Head Office**

118 Campbell Street  
Collingwood VIC  
Australia 3066

—

## **ACN**

600 546 656

—

## **Online**

residentia.group

—

## **Postage**

PO Box 6077  
Collingwood North  
VIC Australia 3066

—

## **Telephone**

1300 11 4357

—

## **Email**

support@residentia.group

Congratulations on purchasing your washing machine. The Esatto brand is proudly distributed within Australia by Residentia Group Pty Ltd.

Please refer to the warranty card at the rear of this manual for information regarding your product's parts and labour warranty, or visit us online at: [www.residentia.group](http://www.residentia.group)

At Residentia Group, we are customer obsessed and our Support Team are there to ensure you get the most out of your appliance. Should you want to learn more about your washing machine such as the various washing modes or importantly taking care of the appliance, our Support Team are here to help.

You can use our online Support Centre at anytime by visiting:  
<http://support.residentiagroup.com.au>

Or you can contact us via phone by dialing: 1300 11 HELP (4357).

It is important that you read through the following use and care manual thoroughly to familiarise yourself with the installation and operation requirements of your appliance to ensure optimum performance.

Again, thank you for choosing an Esatto appliance and we look forward to being of service to you.

Kind Regards,  
The Residentia Team



User Manual:

# Esatto

Contents:

Page:

Safety instructions	4
Installation of the Washer	8
Preperation Before Washing	10
Parts List	11
Operating Your Washer	12
Quick Start	14
The Main Wash	15
Special Features	16
Full Automatic Wash Programs	18
Cleaning & Maintenance	19
Troubleshooting	20
Technical Specifications	22
Warranty information	24
Notes	26



## Safety Instructions

- This appliance is only intended for use within the interior of a domestic environment.
- This appliance is not intended for use by persons (including children) with reduced physical, sensory or mental capabilities, or lack of experience and knowledge, unless they have been given supervision or instruction concerning use of the appliance by a person responsible for their safety.
- Children should be supervised to ensure that they do not play with the appliance.
- Never insert your hands, or try to remove clothes from inside the washing machine, until the drum has completely stopped spinning.

### UNPACKING

- During transportation, protective packaging was used to protect the appliance against any damage. After unpacking, please dispose of all elements of packaging in a way that will not cause damage to the environment. All materials used for packaging the appliance are environmentally friendly; they are 100% recyclable and are marked with the appropriate symbol.

**Caution!** During unpacking, the packaging materials (polythene bags, polystyrene pieces, etc.) should be kept out of reach of children.



### DISPOSAL OF THE APPLIANCE

- Old appliances should not simply be disposed of with normal household waste, but should be delivered to a collection and recycling centre for electric and electronic equipment. A symbol shown on the product, the instruction manual or the packaging shows that it is suitable for recycling.
- Materials used inside the appliance are recyclable and are labeled with information concerning this. By recycling materials or other parts from used devices you are making a significant contribution to the protection of our environment.
- Information on appropriate disposal centres for used devices can be provided by your local authority.









## Safety Instructions

Observe the following items in order to prevent from injuring yourself, others and the damage of property:



	<b>Warning</b>	This indicates serious injury or death to human being may be caused.
	<b>Caution</b>	This will remind you that injury to people and damage to property may occur.

Please observe following contents of graphics.

	This graphics represents(cause attention), and detailed cautions will be displayed inside the graphics. 
	This graphics represents (operation prohibited), and detailed prohibitive items will be displayed inside the graphics. 
	This graphic represents (forcible execution), and detailed forcible execution items will be displayed inside the graphics. 
	This appliance is not intended for use by persons (including children) with reduced physical, sensory or mental capabilities, or lack of experience and knowledge, unless they have been given supervision or instruction concerning use of the appliance by a person responsible for their safety. Children should be supervised to ensure that they do not play with the appliance.

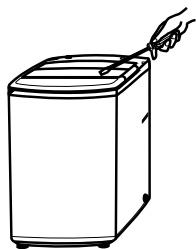

 **Warning**

Please do not disassembly and assembly the machine without authorization.

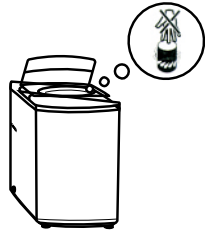

No dismantling

Please do not insert your hand and take out clothes inside the spin barrel before it is fully stopped.

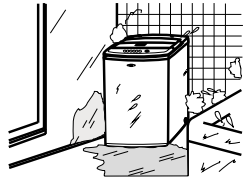

No touching

Please do not install the machine in damp and raining environment to avoid electric shocking, catching fire, faults and distortion accidents.

No dampness

Please do not directly rinse the machine with water when cleaning.

No rinsing

## Safety Instructions



### Warning

Please do not let children climb the machine or peer into the rotating spin barrel to avoid accidents.



Prohibited

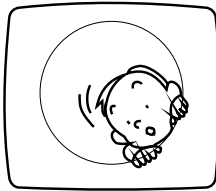

It is prohibited to wash the clothes touching with kerosene, gasoline, alcohol and other flammable materials.



Prohibited

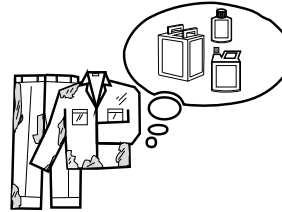

Please do not damage power flexible cord and power plug to avoid electric shocking, short circuit and catching fire.



Prohibited

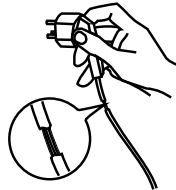

Regularly clean the power plug to remove dust and dirt to avoid contact failure.

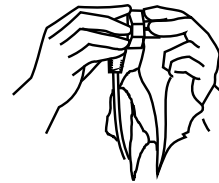

Please pull out plug from the socket if the machine is not in use.



Pull out the plug

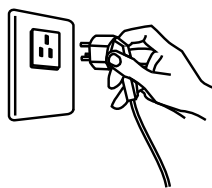

Please well connect the earth line of socket to avoid electric shocking by accidental leakage.

( earthing )



Earthing

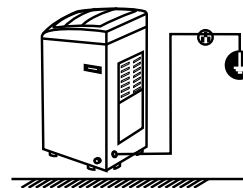

Please insert the power plug tightly.

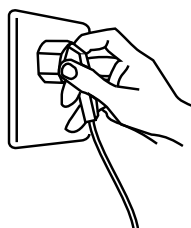

Please do not place on the washer burning candle, mosquito-repellent incense, cigarette and other flammable things, as well as electric stove, air heating fan and other heating sources.



Smoke and fire prohibited



## Safety Instructions

Please use correct power source.

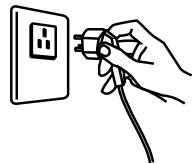

Please do not pull out or insert the plug with wet hands to avoid electric shocking.



Wet hands are prohibited

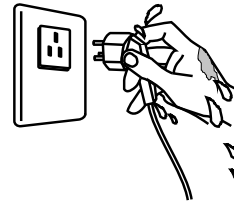

### Caution

Please ensure that the water inlet pipe is connected and the tap is opened before washing clothes.

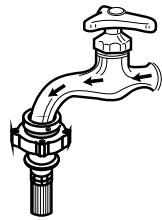

The water temperature shall not exceed 50°C when washing with warm water.



Prohibited



Customers are not allowed to change the power line without permission.



Prohibited

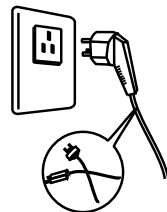

It is strictly prohibited to place children or lay weights on the washer.



Prohibited

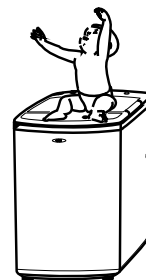

Please do not pull the electric cord when pulling out the plug.

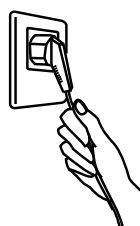

Please do not wash down jacket, raincoat, fishing coat and similar clothes in the washer.



Prohibited

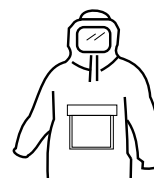

## Installation of the Washer

### Remove package

- Remove package and take out the bottom board of the cabinet on the foam cover.
- Open the lid of washer's door and take out accessories.
- A trial operation or washing on the foamed cushion is strictly forbidden.

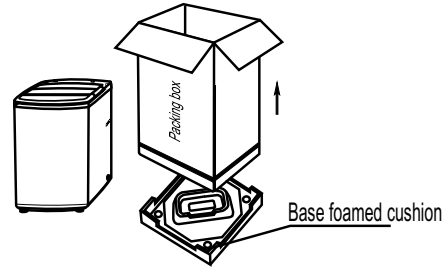

### Installation of drain hose

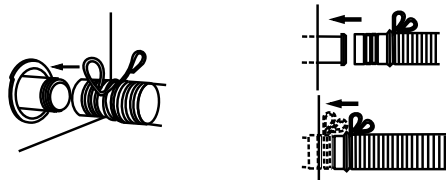

- Completely sleeve the drain hose over the sewer.
- Fix and tighten it with a hoop.  
( As shown in the figure )

### Placement of water drain hose

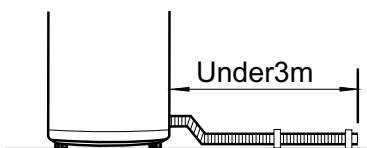

If the water drain hose shall be extended, its length shall not exceed 3 meters, otherwise it will affect the water discharging time.

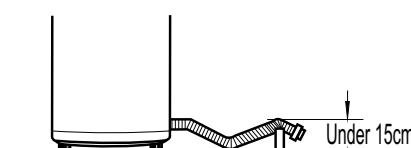

The placed height of water drain hose shall not exceed 15cm.

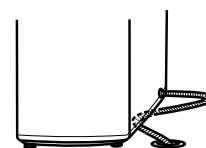

Do not bend the water drain hose and place it under the washer.

**FOR LOWER DRAIN SYSTEM ONLY**

### Placement of upper water drain hose

- The height of drain hose ("a") should be between 86-100 cm.
- Diameter of "b" should not be less than 3 cm, and flow capacity not less than 40 L/Min.
- Before washing machine starts, user should hang up the drain pipe 86-100cm height from the floor.

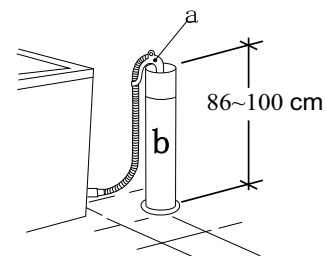

**FOR UPPER DRAIN SYSTEM ONLY**

### Installation of water inlet pipe

- Put the water inlet pipe (which has a metallic filtering bag) screw on to the tap.
- Tightly screw another end of the water inlet hose on the water inlet valve (with a rubber seal ring inside).

Note: When tightening the clamping nut, evenly apply the force and do not twist the water inlet valve to avoid breaking of the water inlet valve joint.

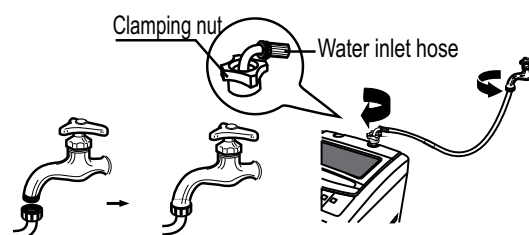

**Only for model with double screw thread water inlet pipe**

## Installation of the Washer

### Installation of water inlet pipe

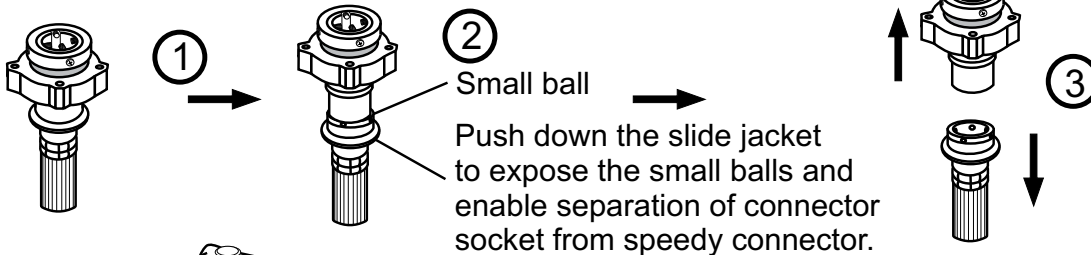

Small ball  
Push down the slide jacket to expose the small balls and enable separation of connector socket from speedy connector.

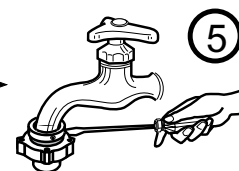
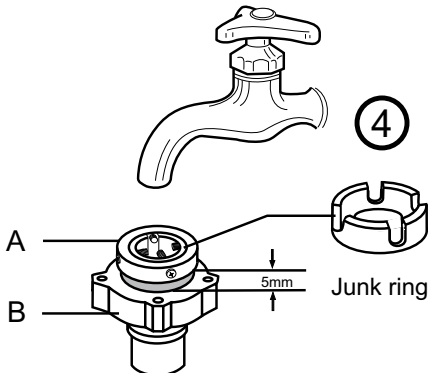

Unscrew four screws of part A and sleeve part A horizontally over the mouth at the end of water tap (the mouth at the end of water tap must be flat and smooth. Flatten it by filing if it is not flat) and push it upward with force making the rubber washer firmly press the plane center of water tap mouth.

Then tighten the screw sequentially. After that, tightly screw on part B.

The connection socket consists of A and B two parts. Before installation, A and B two parts must be unscrewed about 5mm, or directly disconnected. If the bore of water tap is larger, remove the plastic junk ring of part A.

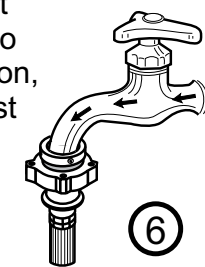

Connect

Connect: Push down the slide jacket of speedy connector (4 small balls must be exposed), insert it into the connection socket and then push upward. Release the connection of water tap with speedy connector completely. If it is required to feed water, simply open the water tap. Separate: Close the water tap, push down the slide jacket of speedy connector and pull out the speedy connector.

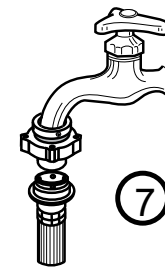

Separate

Tightly screw another end of water inlet hose on water inlet valve. (with rubber seal ring inside).

Note: When tightening the clamping nut, evenly apply the force and do not twist the water inlet valve to avoid breaking of water inlet valve joint.

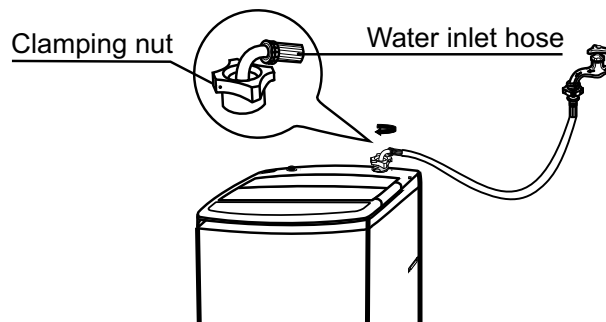

Only for model with single screw thread water inlet pipe



If the supply cord is damaged, it must be replaced by the manufacturer, its service agent or similarly qualified persons in order to avoid a hazard. **The new hose-sets supplied with the appliance are to be used and that old hose-sets should not be reused.** The openings must not be obstructed by a carpet. This appliance is for indoor use only.

## Preparation Before Washing

### 1 Adjust the adjustable foot to make the washer be placed stable.

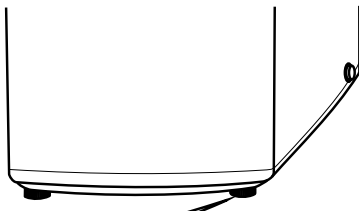

Adjustable foot (extend when clockwise rotating and shorten when counterclockwise rotating)

(Slightly incline the washer first and loosen the adjustable foot knob. Adjust the adjustable foot so as to ensure four corners of washer be steadily contacted with the ground. Then tighten the adjustable foot knob and lock it. If the ground is obviously not flat, correction should be made on the ground surface, otherwise the washer barrel will incline and knock the cabinet)

### 2 Install the water inlet hose.

For one inlet hose

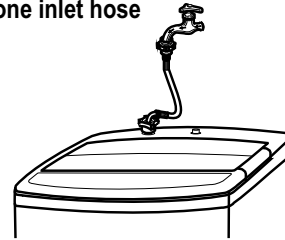

For two inlet hoses

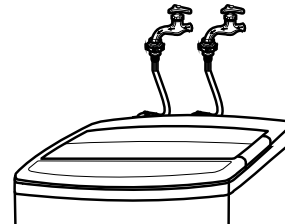

### 3 Connect with to power source.

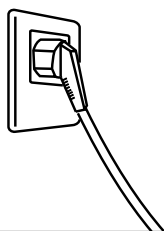

### 5 Put down the drain hose.

Gravity drain

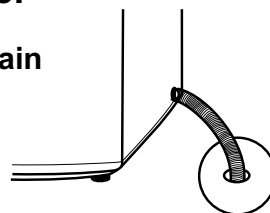

Upper drain

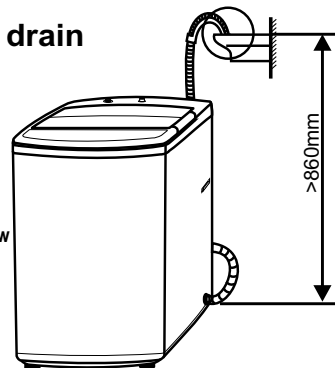

Note:  
The water will overflow when the height of the drain hose under 860mm.

### 6 Put in clothes and suitable amount of washing powder.

### 4 Turn on the water supply.

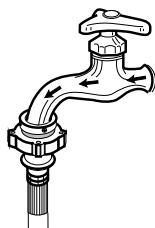



**NOTICE** Before washing, please do take out coins, keys and other hard goods, and zip up clothes tightly to prevent them and barrel from damage.

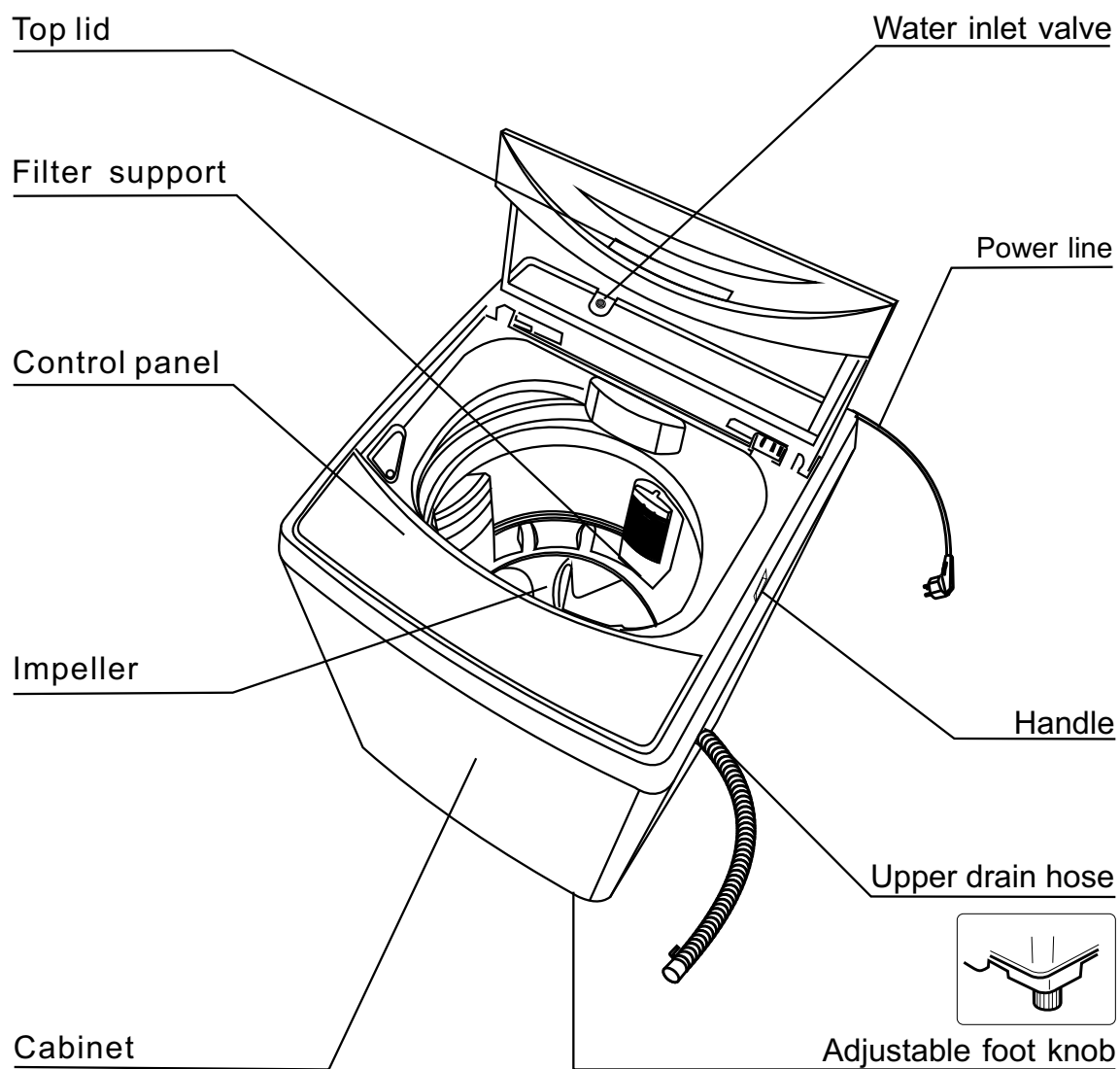

## Parts List

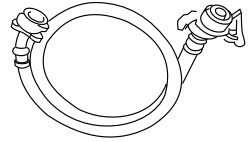
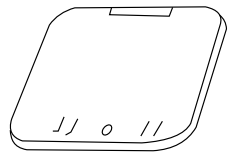

Accessories		
 <p>Universal connector</p>	 <p>Self-tapping screw</p>	 <p>Owner's manual</p>
 <p>Water inlet hose assembly</p>	 <p>Base cover</p>	

Please refer to the real material as the attachment

## Operating Your Washer

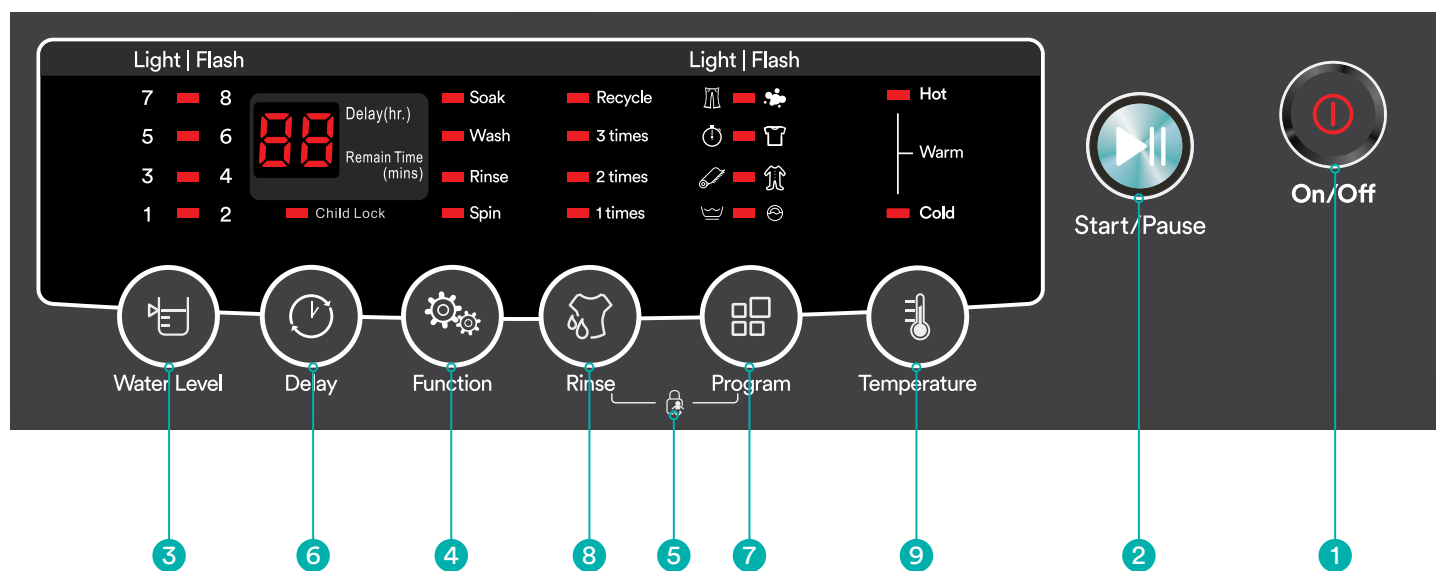

### Three washing water levels description

"Three washing water levels" laundry concept: (suitable for the program which have soak function), the water level of "soak"/"washing"/"rinsing" will be raised in turn automatically, when soaking, it will be low water level, when washing, it will be mid water level, when rinsing, it will be high water level. If consumer select "soaking" program: the water levels selection will be 4, when running soaking, the water level only reach to the 4th level, the water level display will show 4 levels. when the program come into washing period, the water inlet will reach to the 5th level, the water level display will show 5 levels, and then run the washing process. when the program come into the rinsing period, the water inlet will reach to the 6th level, the water level display will show 6 levels.



## Operating Your Washer

### 1. On/Off

---

The [On/Off] button has the function to turn the power supply on or off.

### 2. Start/Pause

---

This button controls the Starting and Pausing functions. Continuously press [Start/Pause] and the machine will switch between start and pause.

### 3. Water Level Selection

---

Before washing, the water level can be selected here according to the amount of materials, weight of clothes or the level of dirt.

### 4. Function

---

After the start, one light will flash between the functions of Soak, Wash, Rinse and Spin according to the process.

### 5. Child Lock

---

Press the [Start/Pause] button to start the program, then press the [Program] and [Rinse] button at the same time to activate the child lock function. The child lock function locks the selected program. To deactivate the function, re-press the [Program] and [Rinse] button at the same time.

### 6. Delay

---

To increase the delay time, hold down the [Delay] button (every 0.5 seconds it is held down will increase the time by 1 hour). After 24 hours, a single beep will be emitted and it will return to “no delay”. After “delay” starts, do not press the [Child Lock] combination, and at this stage you can review the set programs by pressing the [Delay] button again. When “delay” starts, an alarm will go off if the lid is left open and will stop when the lid is closed.

### 7. Program Selection

---

Before starting, press the [Program] button continuously to select the corresponding program above.

### 8. Rinse Description

---

The [Rinse] button can only be activated under the normal program. Continuously press this to select the corresponding rinsing times and water cycle function above.

### 9. Temperature

---

Press the [Temperature] button to select different water temperatures for the washing process.

## Quick Start

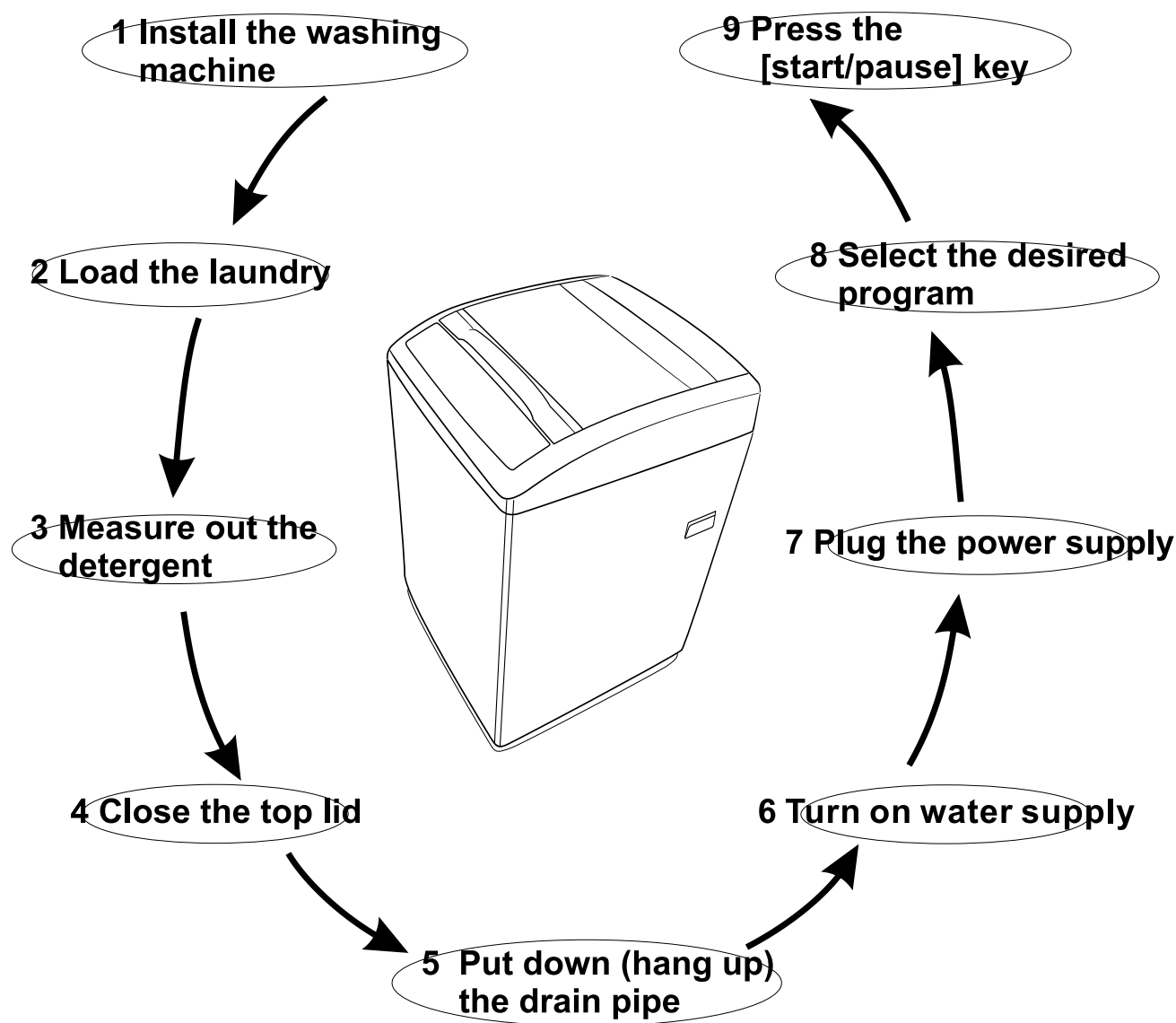

### Main Functions:

#### Preparation:

- 1.Put down the drain pipe;
- 2.Connect the inlet pipe,turn on the tap;
- 3.Put the plug of the power strip into the socket;
- 4.Take out the coins and other things from the pocket,shake off the sediment of the clothes.

### Detailed Steps:

- 1.Press [ON/OFF] button;
- 2.Select the water level according to the washing load;
- 3.Press [Start/Pause] button.

## The Main Wash

### Program Selection:

1. Press [ON/OFF] button;
2. Select the water level and program;
3. Press [Start/Pause] button.

### When washing process finished:

1. The buzzer will buzz continuously for 6 times and then the power will be automatically cut off;
2. Turn off the water tap.
3. Although the power can be cut off automatically, the power plug must be pull out as well for the safety.

### Alarm function when door opened:

1. When washing or spinning, there will be E3 alarm while consumer open the lid, and if consumer close the lid, the alarm will be released, and to continue to run the previous program which before consumer open the lid.
2. When "Delay" starts, there will be "Delay" E3 alarm while consumer open the lid, and if consumer close the lid, the alarm will be released, and to continue the "Delay" function. But while the machine is running, if consumer open the lid, there will be no alarm.

### Pre-Wash for dirty clothes:

For the stubborn clothes which have soil or heavy smudgy, consumer can select the program of "rinsing", "spinning" to pre-wash, after that put the detergent, and then select the full washing programs.

Notice:

1. Do not wash the load with the hot water higher than 50°C, to avoid the deformation of plastic parts;
2. If the water level do not reach to the set level, the washing machine will inlet water itself.

### Clothes Washing Skills:

1. While washing the clothes which are easily damaged, consumer can put those clothes into the mesh bag, and then take the washing process;
2. For the big size or easily floated clothes, should be put into the tub first;
3. For the easily pilling clothes, consumer should turn inside out the reverse side clothes, and then take the washing process;
4. While washing the clothes which have strap or zipper, consumer should tie the strap and zip the zipper well.
5. Remove the sediment before washing;
6. For the especially dirty parts, consumer can scrub with detergent first.



- ! .Close the top lid when machine is running during spin process, otherwise, it will automatically stop working and send out abnormal warning.
- ! .The washer will not work when the filled water does not reach the set water level.

## Special Features

### Delay:

Operation Method:

1. Press [ON/OFF] button;
2. Turn on the tap, put down the drain pipe.
3. Put in the washing load and detergent(Do not sprinkle the detergent on the clothes directly, to avoid the clothes color fading),close the lid;
4. A: While selecting "Soaking", "Jeans", "Baby Clothes" program, press [Delay]button, select the delay time, and then press [Start/Pause] button to start the "delay"program.After "delay" started, the washing machine will take the fuzzy weighting, and then start the "delay"timing.After the fuzzy weighting finished, the washing machine can select the water level within one min, after that, it will come into the formal "delay"status,the buttons can not be operated except [Delay] button,[ON/OFF] button and [child lock] button. B:While selecting"Standard" "Quick", "Blanket", "Delicates", "Drum Clean",press [Delay] button, select the delay time, and then press [Start/Pause] button to start the"delay"program.The buttons can not be operated except [Delay] button, [ON/OFF] button and [child lock]button.

Notice: Long press [Delay] button, every 0.5s will increase 1 hour, and also have a beep once, when after reach to 24 hours, it will return to the initial state.

When "delay" starts, there will be an"delay alarm"if consumer open the lid, and if consumer close the lid, this alarm will be released. But while the machine is running, if consumer open the lid, there will be no alarm. After "delay" starts(do not press "child lock"button), consumer can review the set programs when press [Delay] button again.

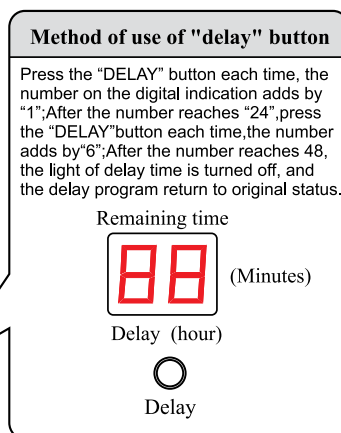

### Child Lock:

1. This function is effective only after program starts;
2. Press [Start/Pause]button to start the program, then press [Rinse] & [Program] button at same time to start the child lock function. If consumer wants to close this function, they can re-press [Rinse]&[Program]button at the same time.
3. When "child lock"started,if open the lid during the running process,there will be an alarm. Open the lid within 20s,there will be a "E3"alarm,if close the lid within 20s,the alarm will be released,and continue to run the previous program which before opening the lid.If the lid opened after 20s,the display will show"CL" alarm named "normal failure alarm",the drain valve will be opened.after the water drained lasting for 90s,the drain valve will be closed. During this process,the alarm still can not be released.The normal alarm will be happened every 15 mins,consumer can power off the machine or unplug to release this alarm.

### Water cycle:

After rinsing, keep the last rinsing water,and do not drain.Water cycle function can be selected only under the Jeans program , and need to have the rinsing process (While consumer select the water cycle function,there will be no draining and spinning after the last rinsing,the water will be kept in the drum.)

### Program Pause and restart:

1. When program paused,all load closed,the controller will stop running;
2. When restart the program,the washing machine will run the program before pausing.

## Special Features

### Fuzzy weighting function:

1. Press "ON/OFF" button;
2. Turn on the tap, put down the drain pipe.
3. Put in the washing load and detergent(Do not sprinkle the detergent on the clothes directly, to avoid the clothes' color fading),close the lid;
4. Select "Soaking","Jeans","Baby Clothes" program. The washing machine will select the water level automatically according to the load weight.
5. Press [Start/Pause] button to run fuzzy weighting function.

Notice:

1. When there's water in the tub,this function is not available;
2. This function can be only applied under the programs of "Soaking","Jeans","Baby Clothes";
3. Before press [Start/Pause] button,if consumer selected the water level,there will be no fuzzy weighting function;
4. After press [Start/Pause] button,the washing machine will run the fuzzy weighting function. Consumer can also select the water level to set the water level as needed.

### Self Power off function:

1. After the program finished,the washing machine will power off automatically;
2. If consumer selected the program but not press the [Start/Pause] button,the washing machine will power off automatically after 10 mins;
3. When alarm happened and was not released,the washing machine will power off after 1 hour;
4. When consumer pressed the [Start/Pause] button during the running process,and forgot to re-press it to continue the program,the washing machine will power off after 1 hour.

### Unbalance Control:

1. During the spin process,and under the condition of safety switch connected,if the sudden break happened,the washing machine will come into the unbalance adjustment situation;
2. While coming into the unbalance adjustment process,the rinsing LED flashed,inlet the water to reach to the set level,adjust the clothes' status,drain after finished rinsing,and return to the normal spinning process.If it is not effective after 3 times' adjustment,there will be an alarm.

### Power failure memory function

If the power supply becomes off suddenly during operation , the machine remembers the current operation state . When power is on ,the machine returns to former operation state automatically.

## Full Automatic Wash Programs

### Standard:

Standard fabric washing program, suitable to wash ramie cotton fabric. Wash for once, rinsing for twice, the spin time is a little long.

### Quick:

Suitable to wash light stained clothes and clothes in summer.

### Blanket:

Suitable to wash big size load such as curtain/bed sheet etc., There's 15mins additional movement soaking time during the washing process. (Movement soak can make the effect of soaking much better.)

### Delicates:

Mid/High/Low water level selection, the tempo is soft, slow washing and spinning speed, to make the lightest wear and deformation.

### Soaking:

Suitable to wash more dirtier clothes, there's 30 mins additional soaking time during the washing process.

### Jeans:

Suitable to wash heavy stained/wearable clothes.

### Baby Clothes:







Increase the rinsing times, to reduce the detergent residue on the clothes. Suitable to wash children's clothes.

### Drum Clean:

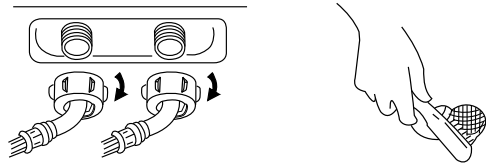
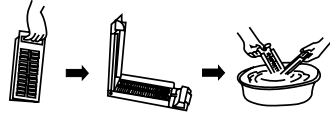
By the intermittent spinning, clean the dirt of inner & outer tub and impeller.

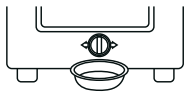
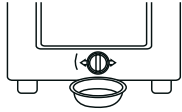
Program	Wash time	Rinse times	Water level	Spin time	Total time
Jeans	15 minutes	2 times	water level for fuzzy	6 minutes	48 minutes
Quick	3 minutes	1 times	2	1 minutes	10 minutes
Blanket	Soak 15 minutes Wash 15 minutes	3 times	7	6 minutes	74 minutes
Delicates	9 minutes	2 times	4	2 minutes	38 minutes
Soaking	Soak 30 minutes Wash 15 minutes	2 times	water level for fuzzy	6 minutes	78 minutes
Standard	Soak 12 minutes Wash 10 minutes	1 times	7	14 minutes	62 minutes
Baby Clothes	12 minutes	3 times	water level for fuzzy	6 minutes	56 minutes
Drum Clean	6 minutes	1 times	8	3 minutes	28 minutes

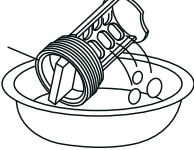
## Cleaning & Maintenance

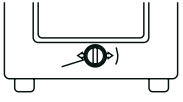
End of program		Maintenance	
<ul style="list-style-type: none"> <li>• The washing machine will send off the sound of “dou-dou” at the end of any program operation to remind you to take out the laundry or operate it again.</li> <li>• After the sound, the washing machine returns to its power-off state with no display and all lights off.</li> <li>• Please shut off the tap, pull out the plug when not in use to avoid water leakage or the fire accidents.</li> </ul>		<p>Use gentle clothing to wipe off the water and dirt on the surface each time after using the washing machine. Detergent, propellant and other chemicals are not allowed to use so as to avoid any damage to the plastic accessories.</p> 	
Clean the water inlet		Clean Of the filter	
<p>After long time use, the water inlet mesh bag may be blocked with smudginess, and should be cleaned according to the following steps:</p> <ol style="list-style-type: none"> <li>1. Switch on the power, followed by shutting off the tap.</li> <li>2. Let the washer works for 5 seconds so that water flows into the tub through the water inlet hose. then turn off the power.</li> <li>3. Unload the water inlet hose and clean the mesh bag, then restore the water inlet assembly.</li> </ol> 		<p>After using the washing machine for a period, please clean it according to the following steps:</p> <ol style="list-style-type: none"> <li>1. Take out the lint filter.</li> <li>2. Open the filter and wash it clean in the water.</li> <li>3. Restore it and fix it.</li> </ol>  <p>(only for magic filter)</p> <p>After using the washing machine for a period, please clean it according to the following steps:</p> <ol style="list-style-type: none"> <li>1. Take off the lint filter.</li> <li>2. Turn over the mesh bag and wash it clean in the water.</li> <li>3. Restore it and fix it.</li> </ol>  <p>(only for normal filter)</p>	
Clean the lint filter in the drain pump (only for having drain filter)			
<p>1. Drain the water out of the pump, under which use a container to collect.</p> 	<p>2. Loosen the pump cover anticlockwise.</p> 	<p>3. Take out the lint filter.</p> 	
<p>4. Clean the filter.</p> 	<p>5. Restore it and adjust the convex place to align at the pump hole.</p> 	<p>6. Tighten the pump cover clockwise.</p> 	

Note: If the drain filter is not cleaned at proper time (every 10 times of use), Drain problem could be caused.



## Troubleshooting

When the washer is in trouble, please contact local service office or the sales service department of our company and the customer should not dismantle the machine without permission.

If the washer can not work normally, or appear abnormality or alarms, please check and correct as follows.

### List of faults and inspection

Faults	Inspection Items
No water flows in	<ul style="list-style-type: none"> <li>● If the power is off or the fuse is burned out.</li> <li>● If the water supply is cut off or the water pressure is too low.</li> <li>● If the inlet hose is properly connected and the water tap is opened.</li> <li>● If the filtering screen of inlet valve is blocked by dirt.</li> <li>● If the coil of inlet valve is damaged. (The slight electromagnetic sound is normal phenomenon when the inlet valve is switched on)</li> <li>● If the "Start / Pause" button is pressed after the power switch is pressed.</li> </ul>
No washing	<ul style="list-style-type: none"> <li>● If the power is off or the fuse is burned out.</li> <li>● If the power supply voltage is too low.</li> <li>● If the water amount reaches to the required water level. (The washer will not work if the water amount does not reach the required water level)</li> <li>● If it is set to "Delay" washing mode. (It will only start to work until the reservation time reached)</li> </ul>
Abnormal draining	<ul style="list-style-type: none"> <li>● If the water drain hose is placed very high.</li> <li>● If the end of water drain hose is sealed in pond.</li> <li>● If the internal rubber ring of drain valve is blocked by dirt.</li> </ul>
Abnormal spin	<ul style="list-style-type: none"> <li>● If the door lid is closed.</li> <li>● If all clothing piled largely at one side of barrel or the clothing is excessively placed.</li> <li>● If the washer is not placed in stable condition or it is placed in inclination state. (The ground is not flat).</li> <li>● If the motor belt is loosened.</li> </ul>

Note: During the de spin process, if washing are piled at one side of the spin barrel, it will cause unbalance of spin barrel resulting in striking. At this moment, the computer inside the washer will feel this unbalance phenomenon and will automatically correct it ( fill in water Washing ). However, if unbalance situation is not removed after continuous three corrections, which means the computer auto-correction can not resolve the problem. Then the user has to manually and evenly place the clothing inside the barrel to solve the problem.



## Troubleshooting

When the washer is in trouble, please contact local service office or the sales service department of our company and the customer should not dismantle the machine without permission.

If the washer can not work normally, and the abnormal indication is shown in the digital display window or the machine alarms, please check and correct as follows.

Falut	Cause of fault	Indication	Alarm of the buzzing sound	Stopping alarm
Alarm for water inlet	Water injection for about 30 mins, but do not reach preset water level.	“E1”flares	The buzzer goes on buzzing for 10 seconds. If the fault is not solved, buzzes again for 10 seconds in every 15minutes.	Open the lid to deal with faults, then close the lid to stop the alarm.
Drain Alarm	Drain off water 10 mins not arrive at empty water level.	“E2”flares		
Alarm for opening lid	Open the lid during washing or spinning process. Open the lid after start the delay time.	“E3”flares		
Imbalance Alarm	Checked imbalance for the third time.	“E4”flares		

Note:The program which has E4 alarm when shocked in the first time is “Drum Clean”.

## Technical Specifications

<b>Model</b>	<b>ETLW55</b>	<b>ETLW7</b>
<b>Size</b>	530X542X925(mm)	550X565X930(mm)
<b>Rated input power</b>	340W	480W
<b>Rated voltage</b>	240V~	240V~
<b>Rated frequency</b>	50Hz	50Hz
<b>Weight of the product</b>	32kg	34kg
<b>Rated capacity of wash and spinning</b>	5.5kg (dry clothes)	7.0kg (dry clothes)
<b>Maximum water pressure permitted in the water inlet</b>	0.6Mpa	0.6Mpa
<b>Minimum water pressure permitted in the water inlet</b>	0.1Mpa	0.1Mpa



This page  
is intentionally  
left blank

## Warranty

### WARRANTY TERMS AND CONDITIONS LAUNDRY APPLIANCES

→ This document sets out the terms and conditions of the product warranties for Residentia Group Appliances. It is an important document. Please keep it with your proof of purchase documents in a safe place for future reference should you require service for your Appliance.

1. In this warranty
  - (a) 'acceptable quality' as referred to in clause 10 of this warranty has the same meaning referred to in the ACL;
  - (b) 'ACL' means Trade Practices Amendment (Australian Consumer Law) Act (No.2) 2010;
  - (c) 'Appliance' means any Residentia Group product purchased by you accompanied by this document;
  - (d) 'ASR' means Residentia Group authorised service representative;
  - (e) 'Residentia Group' means Residentia Group Pty Ltd of 118 Campbell Street Collingwood VIC 3181, ACN 600 546 656 in respect of Appliances purchased in Australia;
  - (f) 'major failure' as referred to in clause 10 of this warranty has the same meaning referred to in the ACL and includes a situation when an Appliance cannot be repaired or it is uneconomic for Residentia Group, at its discretion, to repair an Appliance during the Warranty Period;
  - (g) 'Warranty Period' means:
    - (i) where the Appliance is used for personal, domestic or household use (i.e. normal single family use) as set out in the instruction manual, the Appliance is warranted against manufacturing defects in Australia for 24 months following the date of original purchase of the Appliance;
  - (h) 'you' means the purchaser of the Appliance not having purchased the Appliance for re-sale, and 'your' has a corresponding meaning.
2. This warranty only applies to Appliances purchased and used in Australia and is in addition to (and does not exclude, restrict, or modify in any way) any non-excludable statutory warranties in Australia.
3. During the Warranty Period Residentia Group or its ASR will, at no extra charge if your Appliance is readily accessible for service, without special equipment and subject to these terms and conditions, repair or replace any parts which it considers to be defective. Residentia Group or its ASR may use remanufactured parts to repair your Appliance. You agree that any replaced Appliances or parts become the property of Residentia Group. This warranty does not apply to light globes, batteries, filters or similar perishable parts.
4. Parts and Appliances not supplied by Residentia Group are not covered by this warranty.
5. You will bear the cost of transportation, travel and delivery of the Appliance to and from Residentia Group or its ASR. If you reside outside of the service area, you will bear the cost of:
  - (a) travel of an authorised representative;
  - (b) transportation and delivery of the Appliance to and from Residentia Group or its ASR, in all instances, unless the Appliance is transported by Residentia Group or its ASR, the Appliance is transported at the owner's cost and risk while in transit to and from Residentia Group or its ASR.
6. Proof of purchase is required before you can make a claim under this warranty.

**Warranty continued**

7. You may not make a claim under this warranty unless the defect claimed is due to faulty or defective parts or workmanship. Residentia Group is not liable in the following situations (which are not exhaustive):
- (a) the Appliance is damaged by:
    - (i) accident
    - (ii) misuse or abuse, including failure to properly maintain or service
    - (iii) normal wear and tear
    - (iv) power surges, electrical storm damage or incorrect power supply
    - (v) incomplete or improper installation
    - (vi) incorrect, improper or inappropriate operation
    - (vii) insect or vermin infestation
    - (viii) failure to comply with any additional instructions supplied with the Appliance;
  - (b) the Appliance is modified without authority from Residentia Group in writing;
  - (c) the Appliance's serial number or warranty seal has been removed or defaced;
  - (d) the Appliance was serviced or repaired by anyone other than Residentia Group, an authorised repairer or ASR.
8. This warranty, the contract to which it relates and the relationship between you and Residentia Group are governed by the law applicable where the Appliance was purchased.
9. To the extent permitted by law, Residentia Group excludes all warranties and liabilities (other than as contained in this document) including liability for any loss or damage whether direct or indirect arising from your purchase, use or non use of the Appliance.
10. For Appliances and services provided by Residentia Group in Australia, the Appliances come with a guarantee by Residentia Group that cannot be excluded under the Australian Consumer Law. You are entitled to a replacement or refund for a major failure and for compensation for any other reasonably foreseeable loss or damage. You are also entitled to have the Appliance repaired or replaced if the Appliance fails to be of acceptable quality and the failure does not amount to a major failure. The benefits to you given by this warranty are in addition to your other rights and remedies under a law in relation to the Appliances or services to which the warranty relates.
11. At all times during the Warranty Period, Residentia Group shall, at its discretion, determine whether repair, replacement or refund will apply if an Appliance has a valid warranty claim applicable to it.
12. To enquire about claiming under this warranty, please follow these steps:
- (a) carefully check the operating instructions, user manual and the terms of this warranty;
  - (b) have the model and serial number of the Appliance available;
  - (c) have the proof of purchase (e.g. an invoice) available;
  - (d) telephone the numbers shown below.
13. You accept that if you make a warranty claim, Residentia Group and its ASR may exchange information in relation to you to enable Residentia Group to meet its obligations under this warranty.

**IMPORTANT** Before calling for service, please ensure that the steps in point 12 have been followed.

→ Service: Please call 1300 11 HELP (4357)



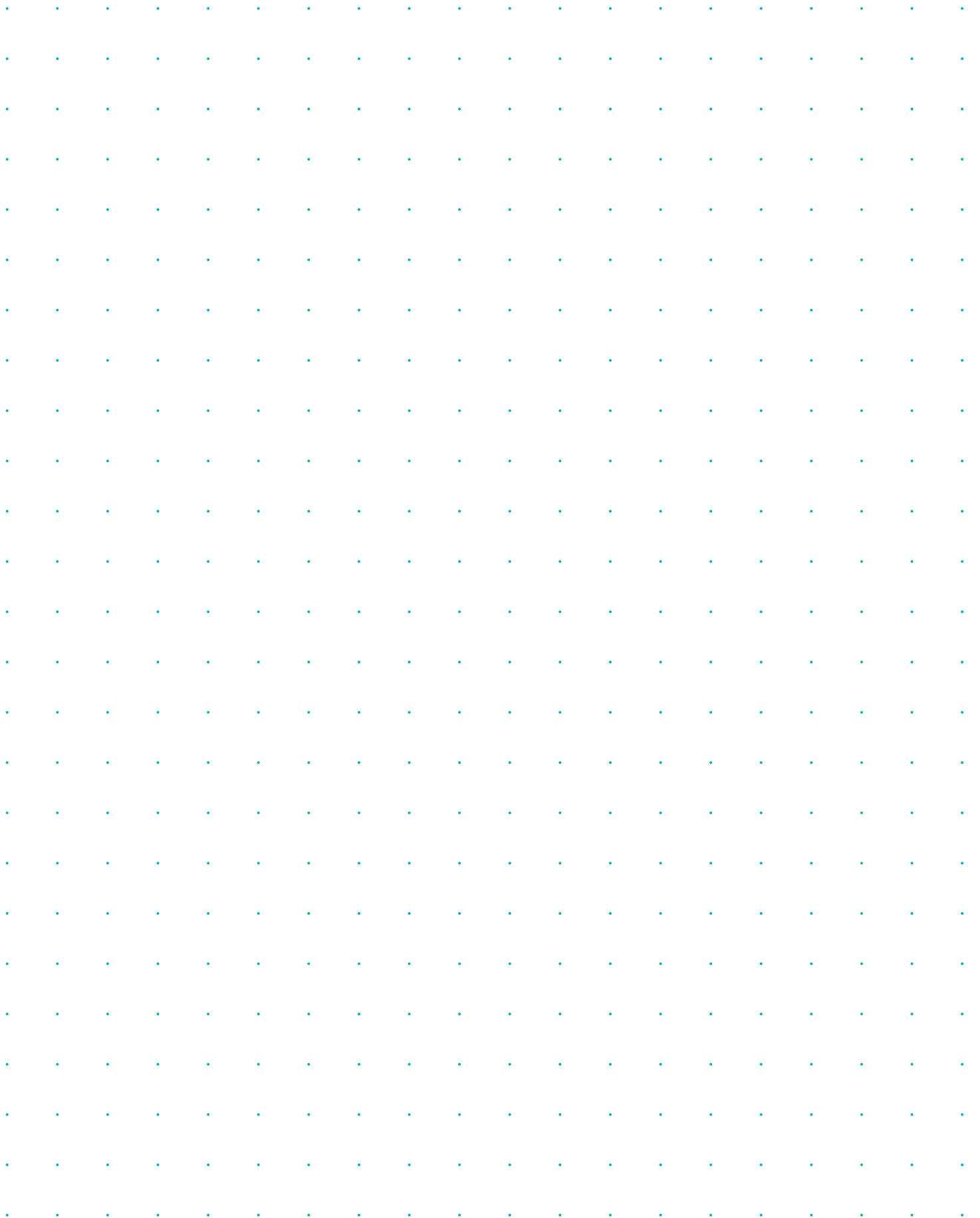



E2447

# Esatto

# Appliances

# Exactly what

# you need



A RESIDENTIA  
GROUP INITIATIVE