

Product:

Hybrid Chest - 142L  
Fridge/Freezer - 198L

Capacity:

Model Code/s:

- ECF142WE  
- ECF198WE

# Esatto

## User Manual

Exactly what  
you need

Online:

[esatto.house](https://esatto.house)

**Residentia Group Pty Ltd**

ACN 600 546 656

—

Head Office.

118 Campbell Street

Collingwood, VIC

Australia 3066

—

Postage.

PO Box 341, Mt Eliza

Victoria Australia 3930

—

Support.

1300 11 4357

support@residentia.group

—

Online.

residentia.group

---

Congratulations on purchasing your new fridge. The Esatto brand is proudly distributed within Australia by Residentia Group Pty Ltd.

Please refer to the warranty card at the rear of this manual for information regarding your product's parts and labour warranty, or visit us online at [www.residentia.group](http://www.residentia.group)

At Residentia Group, we are customer obsessed and our Support Team are there to ensure you get the most out of your appliance. Should you want to learn more about recommended temperatures, the various features of your fridge, and importantly taking care of your appliance when cleaning, our Support Team are here to help. You can use our online Support Centre at anytime by visiting <http://support.residentia.group.com.au>, or you can contact us via calling us on 1300 11 HELP (4357).

It is important that you read through the following use and care manual thoroughly to familiarise yourself with the installation and operation requirements of your appliance to ensure optimum performance.

Again, thank you for choosing an Esatto appliance and we look forward to being of service to you.

Kind Regards,  
The Residentia Team



# Contents

---

<b>2</b>	<b>Welcome</b>
<b>4</b>	<b>Purchase Details</b>
<b>5</b>	<b>General Safety Instructions</b>
<b>8</b>	<b>Product Overview</b>
<b>10</b>	<b>Getting Started</b>
<b>10</b>	<b>Installation</b>
<b>11</b>	<b>Using Your Chest Freezer</b>
<b>13</b>	<b>Tips for Using the Appliance</b>
<b>13</b>	<b>Tips for Energy Saving</b>
<b>14</b>	<b>Maintenance and Cleaning</b>
<b>16</b>	<b>FAQs and Troubleshooting</b>
<b>17</b>	<b>Specifications</b>
<b>18</b>	<b>Warranty Returns</b>

---

# Purchase Details

---

For future reference, please record the following information which can be found on the rating plate and the date of purchase which can be found on your sales invoice.

---

## STORE DETAILS

---

STORE NAME |

ADDRESS |

TELEPHONE |

PURCHASE DATE |

---

## PRODUCT DETAILS

---

MODEL NO. |

SERIAL NO.\* |

# General Safety Instructions

---

## IMPORTANT SAFETY INSTRUCTIONS READ CAREFULLY AND KEEP FOR FUTURE REFERENCE

Read this manual thoroughly before first use, even if you are familiar with this type of product. The safety precautions enclosed herein reduce the risk of fire, electric shock and injury when correctly adhered to. Make sure you understand all instructions and warnings.

Keep the manual in a safe place for future reference, along with the completed warranty card and purchase receipt. If you sell or transfer ownership of this product, pass on these instructions to the new owner.

Always follow basic safety precautions and accident prevention measures when using an electrical appliance, including the following:

**IMPORTANT:** Pay particular attention to messages that contain the words **DANGER, WARNING** or **CAUTION**. These words are used to alert you to a potential hazard that can seriously injure you and others. The instructions will tell you how to reduce the chance of injury and let you know what can happen if the instructions are not followed.



This symbol alerts you to take care as this appliance contains a flammable refrigerant (isobutane) and insulation blowing gas (cyclopentane). Do not expose it to high heat, sparks and open flames.

The refrigerant isobutane (R600a) is contained within the refrigerant circuit of the appliance, a gas with a high level of environmental compatibility, which is nevertheless flammable. During transportation and installation of the appliance, ensure that none of the components of the refrigerant circuit become damaged.

**WARNING:** Do not damage the refrigerant circuit! Never use an appliance with a damaged refrigerant circuit! If the refrigerant circuit becomes damaged, avoid proximity to open fires and all types of heat and ignition sources. Thoroughly ventilate the room in which the appliance is located.

**DANGER:** It is hazardous for anyone other than an authorised service person to service this appliance. In Queensland, the authorised service person MUST hold a Gas Work Authorisation for hydrocarbon refrigerants to carry out servicing or repairs which involve the removal of covers.

The room for installing the appliance must be at least 1m<sup>3</sup> per 8g of refrigerant. The amount and type of refrigerant in the appliance can be found in the Technical Specifications on page 17 and on the rating plate, found on the appliance.

### Usage Conditions and Restrictions

- **Domestic use only:** This appliance is intended for indoor household use only. It is not intended for commercial, industrial or outdoor use. It is not intended for use in a recreational vehicle.
- **Purpose:** Do not use this appliance for anything other than its intended purpose. Other uses are not recommended and may cause fire, electric shock or personal injury.
- **Attachments:** The use of attachments is not recommended by the appliance manufacturer and distributor as they may be hazardous.
- **Improper use:** Damage due to improper use, or repairs made by unqualified personnel will void your warranty. We assume no liability for any eventual damages caused by misuse of the product or noncompliance with these instructions.

## General Safety Instructions Cont.

- **WARNING:** Do not use mechanical devices or other means to accelerate the defrosting process, other than those recommended by the manufacturer.
- **Usage restriction:** This appliance is not intended for use by persons (including children) with reduced physical, sensory or mental capabilities, or lack of experience and knowledge, unless they have been given supervision or instructions concerning use of the appliance by a person responsible for their safety.
- **Children:** Supervise young children to ensure they do not play with the appliance. Never allow children to operate, play with or crawl inside the appliance.
- **WARNING:** Do not use electrical appliances inside the appliance, unless they are of the type recommended by the manufacturer.
- **Explosive or flammable substances:** Do not store explosive substances such as aerosol cans with a flammable propellant in this appliance. Do not store or use petrol or any other flammable vapours and liquids in the vicinity of this or any other appliance. Do not use such substances for cleaning the appliance. The fumes can create a fire hazard or an explosion.
- **Damage:** Do not use the appliance if the power cord, plug or the appliance itself is damaged. If the cord is damaged, contact the after sales support line and have the cord replaced by qualified personnel in order to avoid a hazard.
- **WARNING:** Do not damage the refrigerant circuit.
- **Do not modify:** Do not attempt to alter or modify this appliance in any way.
- **Repair:** Do not attempt to repair or replace any part of this appliance unless it is specifically recommended in this manual. All other servicing should be referred to a qualified technician. Contact the after sales support line for advice.

## Electrical Safety

- **Voltage:** Before connecting and turning on the appliance, ensure the electrical voltage and circuit frequency correspond to that indicated on the appliance rating label.
- **Earthing:** This appliance should be properly earthed for your safety. The power cord of this appliance is equipped with a three-prong plug for use in standard wall outlets to minimise the possibility of electrical shock. Do not modify the cord and/or plug provided with the appliance. Improper use of the earthed plug can result in the risk of electric shock.
- **Connection:** This appliance requires a standard 220-240 V AC 50Hz electrical outlet. Do not overload the electrical circuit.
- **Power cord:** Do not kink or damage the power cord; do not leave it exposed or dangling. Secure it at the back of the appliance so no one steps on or places anything on the cord or against it. Keep the cord out of reach of children. When moving the appliance, make sure not to damage the power cord.
- **Auxiliary Items:** Do not use an inverter, adaptor or extension cord with this appliance. If the cord is too short, have a qualified electrician install an outlet near the appliance. Use of an extension cord and an inverter can negatively affect the performance of the unit.
- **Protect from moisture:** To protect against the risk of electric shock, do not immerse the unit, cord or plug in water or spray it with any other liquid. Do not connect or disconnect the electric plug when your hands are wet. Turn the power switch off before removing the plug from the socket.
- **WARNING: Disconnect!** To reduce the risk of fire, electric shock or personal injury, always unplug the appliance from the socket when not in use, when moving and before cleaning or servicing. Never unplug the unit by pulling the power cord. Always grip the plug firmly and pull straight out from the power point.
- **Electrical work:** Any electrical work required for the installation of this appliance should be carried out by a qualified electrician.

**Never use this appliance with a damaged refrigerant circuit!** If the coolant circuit becomes damaged, avoid proximity to open fires and all types of heat sources. The room in which the appliance is located should be ventilated for a few minutes.

## General Safety Instructions Cont.

### Installation

**Heavy:** This appliance is heavy, take care when moving it. To avoid back or other injury, consider a two person lift or mechanical aid when installing it. Failure to do so can result in back or other injury.

**Damage:** When unpacking, check the appliance carefully for damage. If it is damaged, do not install the appliance. Contact our after sales support centre on 1300 43 57 for advice on examination or return of the damaged appliance.

**Protect from moisture:** Install the appliance in an indoor area protected from wind, rain, water spray or drips.

**Protect from heat:** Do not install the appliance next to an oven, grill or other source of high heat, or where it will be exposed to direct sunlight for prolonged periods of time.

**WARNING: Ventilation:** To ensure proper ventilation, keep any ventilation openings, in the appliance enclosure or in the built-in structure, clear of obstructions. Ensure adequate air circulation around the appliance to prevent overheating.

**Level:** Install the appliance level in order to ensure proper operation.

### Cleaning and Maintenance

**Disconnect:** Unplug the appliance before cleaning or servicing. Failure to do so can result in electric shock, injury or death. Do not connect or disconnect the plug when your hands are wet.

**Flames:** Do not let open flames or ignition sources enter the appliance.

**Flammable/explosive substances:** Never clean this appliance with flammable fluids. Do not store or use volatile, flammable or explosive propellants or liquids in or close to this or any other appliance. The fumes can create a fire hazard or explosion.

**Solvents:** Do not use solvent based cleaning agents or abrasives on the interior as these may damage or discolour the surfaces of the appliances.

**WARNING!** Do not use mechanical devices or other means to accelerate the defrosting process. Never use a sharp or metal instrument to remove frost or clean the appliance. Use a plastic scraper, if necessary.

**Service:** Do not attempt to repair, modify or replace any part of the appliance unless specifically recommended in this manual. Refer all other servicing to a qualified technician, or contact the after sales support line for advice on examination or repair of the appliance.

### Responsible disposal

**Note:** At the end of its working life, do not throw this appliance out with your household rubbish. Electrical and electronic products contain substances that can have a detrimental effect on the environment and human health if disposed of inappropriately. Observe any local regulations regarding the disposal of electrical consumer goods and dispose of it appropriately for recycling and recovery of the refrigerant and blowing agent. Contact your municipal authorities for advice on recycling facilities in your area.

**WARNING!** This refrigeration appliance contains flammable refrigerants and insulation blowing gases, which must be removed before disposal. Contact your municipal authorities for any codes or regulations concerning the disposal of such materials.

# Product Overview

## Chest Freezer Layout

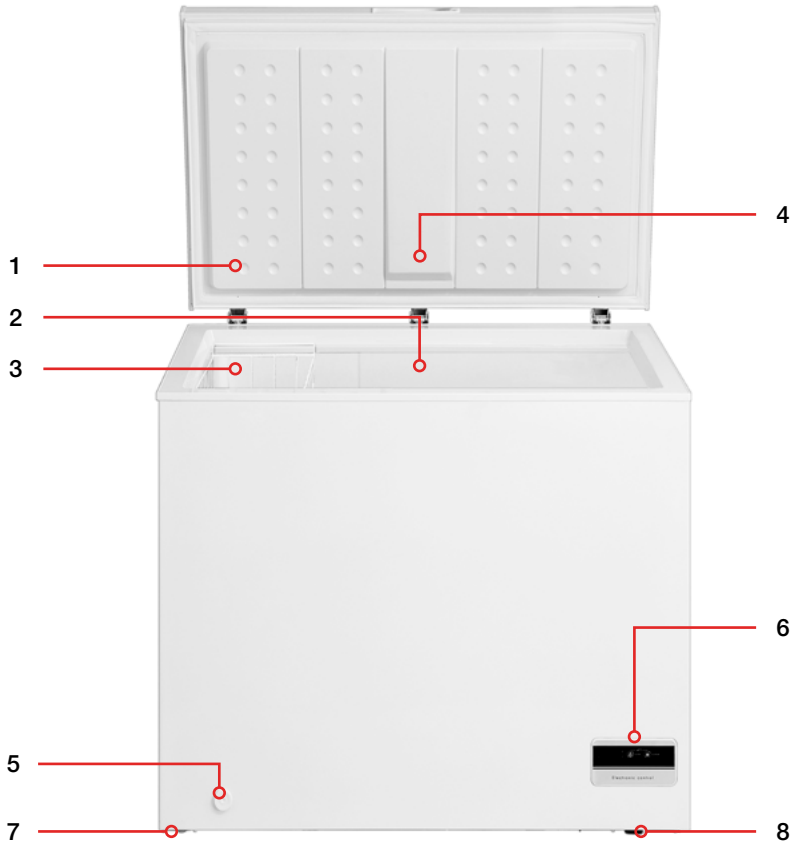

### Key:

- |                                    |                                       |
|------------------------------------|---------------------------------------|
| 1. Counter balanced lid            | 5. Drainage hole                      |
| 2. Freezer compartment             | 6. LED Display & Controls             |
| 3. Wire storage basket (removable) | 7. 2 × Adjustable legs (front + back) |
| 4. Automatic light                 | 8. 2 × wheels (front + back)          |



## Product Overview Cont.

### Control Panel Layout



#### Key:

##### 1. Alarm Lamp

This warns you if the temperature is rising and your food may be spoiled.

##### 2. Quick Freeze Lamp

This indicates that the Quick Freeze function has been activated.

##### 3. LED Display

Displays the set temperature inside the freezer.

##### 4. Quick Freeze Button

Press this to activate or deactivate the Quick Freeze Function.

##### 5. Temperature Adjusting Button

Press the button to set the temperature.

For more details on this, see page 11.

#### Note.

##### • Temperature Units

Press and hold the Temperature Adjusting button for 3 seconds to change the temperature display units from Celsius to Fahrenheit

# Getting Started

## Unpacking

- **Packaging materials:** This appliance has been packaged to protect it against transportation damage. Remove all packaging materials from around and inside the appliance and keep the original packaging carton and materials in a safe place. It will help prevent any damage if the product needs to be transported in the future, and you can use it to store the appliance when it is not in use. In the event the carton is to be disposed of, please recycle all packaging materials where possible.
- **Suffocation:** Plastic wrapping can be a suffocation hazard for babies and young children, so ensure all packaging materials are out of their reach and disposed of safely.
- **Power cord:** Unwind the power cord to its full length and inspect it for damage. Do not use the appliance if it or its cord have been damaged or are not working properly. In case of damage, contact our after sales support line for advice on examination, repair or return of the damaged product.
- **Read the manual:** Read this manual to familiarise yourself with the appliance. Pay particular attention to the safety instructions on the previous pages.
- **Clean:** To remove any dust from transit and storage, clean the interior and exterior surfaces of the appliance with lukewarm water and a soft cloth. Dry thoroughly. **Important:** do not use harsh or abrasive detergents or powders as these will damage the finish.

## Installation

- **Two person installation:** Use two or more people to move and install the appliance. Failure to do so can result in back or other injury.
- **Freestanding design:** This appliance is designed to be freestanding only, and should not be recessed or built-in.
- **Floor surface:** This appliance must be properly positioned on a dry, sturdy, level surface that is strong enough to support it when it is fully loaded.
- **Ambient temperature:** The ambient temperatures must correspond to the climate class (T) indicated on the rating plate of the appliance: 16°C – 43°C.
- **Clearances:** Ensure that air can circulate freely around the back of the cabinet, which is necessary to cool the compressor and condenser. Allow at least 12cm clear space at the back and 5cm at the sides of the unit.
- **Wall Units Above:** Ideally, the appliance should not be positioned below overhanging wall units. However, if the appliance must be positioned below an overhanging wall unit, make sure to allow sufficient room so you can comfortably open the lid and access the contents.

**Do NOT** install/use the appliance in the following locations/situations:

- In moist areas or areas of high humidity.
- In a recreational vehicle, or for use with an inverter.
- In direct sunlight, near heat sources, next to an open flame, cooking or heating appliance, or near any other source of high heat.
- Direct sunlight may affect the acrylic coating and heat sources may increase the unit's power consumption. For best energy efficiency install the appliance in the coolest area of the room.
- In an area with extreme cold ambient temperatures.
- In an area with excessive moisture and high humidity. Make sure it is protected from elements such as wind, rain, water spray or drips.
- In an area where petrol or other explosive and/or flammable liquids or fumes are used or stored. The fumes can create a fire hazard or explosion.

## Installation Cont.

### Electrical connection

- **WARNING!** It must be possible to disconnect the appliance from the mains power supply; the plug must therefore be easily accessible after installation.
- Before plugging in your new freezer, let it stand upright for at least 2 hours. This will allow the refrigerant gases to settle into the compressor and reduce the possibility of a malfunction in the cooling system.
- The appliance must be earthed. The plug of the power supply cord is equipped with a contact for this purpose. Do not under any circumstances cut or remove the third (earth) prong from the power cord. If the plug does not fit your outlet, consult a licensed electrician for advice to have the outlet changed.
- Plug the unit into a dedicated, properly earthed wall outlet. Ensure that your outlet voltage and circuit frequency correspond to the voltage stated on the rating label.
- Secure the freezer's supply cord behind the unit. Do not leave it exposed or dangling to prevent injury and accidental disconnection from the power supply.
- Adjust the temperature control as described below.
- When first starting up, and after a period out of use, allow the unit to cool down for at least 2–3 hours (4 hours if starting up during warm weather in summer) before placing food in the freezer.

## Using Your Chest Freezer

The temperature control is located at the front of the freezer cabinet, in the bottom right corner (Fig. 1).

- **Display:** When powering on the freezer, the display window (Fig. 1, B) illuminates fully for 3 seconds before entering into 'normal' display showing the default temperature:  $-18^{\circ}\text{C}$  ( $0^{\circ}\text{F}$ ). If no error occurs the display panel shows the set temperature or mode (if an error has occurred, the code will show in the display).
- **Locking:** Press the Temperature Adjustment button (Fig. 1, C) and the Quick Freeze button (Fig. 1, D) for 3 seconds at the same time. The display will flash for several seconds and the unit will be locked.
- **Unlocking:** Press the Temperature Adjustment button (Fig. 1, C) and the Quick Freeze button (Fig. 1, D) for 3 seconds at the same time. The unit will exit locked mode, and the temperature can be adjusted.

NOTE: If any functions are attempted while the unit is locked, the display will flash for 3 seconds, signaling an invalid operation.

- **Swapping between Celsius and Fahrenheit:** Press the Temperature Adjustment button (Fig. 1, C) for 3 seconds and the unit of measurement (Fig. 1, F) will swap.



Fig. 1

## Using Your Chest Freezer Cont.

- Swapping the Unit from Freezer to Fridge: While in freezer mode, press the Temperature Adjustment button (Fig. 1, C) until the display shows  $-24^{\circ}\text{C} / -11^{\circ}\text{F}$ . Pressing the Temperature Adjustment button (Fig. 1, C) again will convert the freezer into a fridge and the display will show  $1^{\circ}\text{C} / 34^{\circ}\text{F}$ .
- Swapping the Unit from Fridge to Freezer: While in fridge mode, press the Temperature Adjustment button (Fig. 1, C) until the display shows  $10^{\circ}\text{C} / 50^{\circ}\text{F}$ . Pressing the Temperature Adjustment button (Fig. 1, C) again will convert the fridge into a freezer and the display will show  $-12^{\circ}\text{C} / 10^{\circ}\text{F}$ .
- Adjusting the Temperature while in Freezer mode: Press the Temperature Adjustment button (Fig. 1, C) to change the set temperature. For each press of the button, the set temperature will drop by  $-1^{\circ}\text{C} / ^{\circ}\text{F}$ .
- Adjusting the Temperature while in Fridge mode: Press the Temperature Adjustment button (Fig. 1, C) to change the set temperature. For each press of the button, the set temperature will go up by  $1^{\circ}\text{C} / ^{\circ}\text{F}$ .

NOTE: The unit may not work at the set temperature on particularly hot days, or if the lid is opened too frequently. To ensure efficient operation, do not open the lid unnecessarily or for prolonged periods of time.

NOTE: When the unit is set to  $-24^{\circ}\text{C} / -11^{\circ}\text{F}$ , the compressor will continuously run.

**IMPORTANT:** Once the unit has started, continuous operation is recommended. Please try and avoid turning the unit off and on as this may affect the service life.

- Quick Freeze Mode: To enter Quick Freeze Mode press the Quick Freeze button (Fig. 1, D). The Quick Freeze indicator light will light up (Fig. 1, E). To exit Quick Freeze Mode, press the Quick Freeze button (Fig. 1, D). The Quick Freeze indicator light will then go out.

NOTE: If running in Quick Freeze Mode for a continuous 24 hours, the unit will automatically exit the mode as a safeguard.

- High Temperature Alarm: The High Temperature indicator light (Fig. 1, A) will illuminate if the unit rises above a set temperature and your food may be at risk of spoiling. This may be caused by the lid not being closed properly, by a fault in the unit or a number of other causes. Please contact our after sales support on 1300 11 43 57 if this is an issue you cannot resolve.
- Power Off Memory: In case of power failure, the previous settings will be memorised until the power returns.
- Failure Code: When the failure code **E2** appears on the display screen it means that the temperature sensor has failed. Please contact the after sales support on 1300 11 43 57.

## Tips for Using the Appliance

- Do not store food uncovered in the freezer. Always use good quality, freezer-proof packaging to maintain food quality. Remove air from packages of solid food and seal bags tightly before freezing.
- Keep portions small to ensure they are frozen (and subsequently defrosted) rapidly.
- Make sure that fresh, unfrozen food packages do not touch food that is already frozen, thus avoiding a temperature rise in the frozen food.
- When freezing food, do not push food together too much, leave some space for air to circulate around each item. Do not place packages directly against the back wall.
- When buying frozen food, only buy quantities that you can store straight away; use an insulated container for your shopping and when you get home, place the food in the freezer immediately.
- When storing pre-packed, commercially frozen food, follow the food manufacturer's instructions for storing the food in a home freezer. Do not exceed any storage times listed on the packaging.
- Once you have opened a packet of frozen food, re-wrap it airtight to prevent surface evaporation which causes drying or freezer burn.
- Do not place carbonated liquids such as bottles of fizzy drink in the freezer as the container could explode under pressure and damage the freezer.
- Do not refreeze food once it has been defrosted.
- Frozen food which has thawed accidentally should either be used immediately or thrown away. Alternatively, if the food is uncooked and has not been completely defrosted, it may be cooked and then refrozen.
- **CAUTION!** Do not remove items from the freezer if your hands are damp or wet as this could cause skin abrasions.

## Tips for Energy Saving

- The appliance should be placed in the coolest area of the room, away from heat producing appliances or heating ducts. Please avoid placement in direct sunlight.
- Let hot foods cool to room temperature before placing them in the appliance.
- Do not overload the appliance with unfrozen food as this may cause it to freeze slowly and risk food spoilage.
- Be sure to wrap foods properly and wipe containers dry before placing them in the appliance. This cuts down on frost building up inside in the unit.
- Please do not wrap items in aluminium foil, wax paper or paper towel. This materials interfere with cold air circulation, making the appliance less efficient.
- Organise and label food to reduce door openings and extended searches. Remove as many items as needed at one time, ensuring the unit is opened as few times as possible.

# Maintenance and Cleaning

## Defrosting

The chest freezer requires manual defrost. For efficient operation and minimum energy consumption, defrost the freezer compartment when the frost on the freezer walls is building up. Do not let frost build up to more than 3–4mm thickness. For efficiency, choose a time when your stock of frozen food is low.

- Unplug the freezer and open the door. Remove the food and storage basket. (Keep any frozen food temporarily in a fridge or cooler bag to keep defrosting to a minimum.)
- During defrosting, any ice and frost that has accumulated will melt into the freezer cabinet. To drain the water, open the drainage hole (Fig. 2). When the ice softens, an ice scraper can be used to help speed up the process.



Fig. 2

## Cleaning

### WARNING

Before cleaning the appliance, make sure it is switched off and disconnected from the power supply. Failure to do so can result in electric shock or injury.

- Wash the inside surfaces and the interior accessories with a damp, warm cloth moistened in a water and baking soda solution. The solution should be about 2 tablespoons of baking soda to 1 litre of water. Rinse and wipe dry with a soft cloth.
- Clean the outside of the unit with a damp, well wrung out cloth, keeping the area of the controls dry. Keep the lid gasket (seal) clean.
- **Never use boiling water to accelerate defrosting as it may damage the plastic components.**
- Regularly check the drain in the freezer for defrost water. If necessary, clean the drain. If the drain is blocked, water will collect in the base of the appliance.
- After cleaning/defrosting, push the drain plug in and also re-plug the drain plug inside the freezer cabinet.
- After everything is dry, place appliance back into service.
- Allow approximately 1–2 hours for the cabinet to cool down again (depending on the length of time the freezer was disconnected from the power).

### WARNING

Never clean the unit with an abrasive, acid, oil or solvent based cleaning agent. Never use flammable fluids or sprays for cleaning as the fumes from these substances can create a fire hazard or Explosion.

## Maintenance and Cleaning Cont.

### Interior light

This chest freezer has an interior LED light bulb built into the lid (Fig. 3). It lights and extinguishes automatically when the lid is opened and closed. If the light bulb needs replacing, contact our after sales support on 1300 11 4357 to book a service call. The light bulb can only be replaced by properly qualified service personnel.

### Service, repair and spare parts

Do not attempt to alter or modify this appliance in any way, or to repair or replace any part unless it is specifically recommended in this manual. All other servicing should be referred to a qualified technician. Contact our after sales support on 1300 11 43 57 for advice.

Our after sales support centre stocks a selection of spare parts for the Esatto 142L Chest Freezer. To enquire about purchasing a part, call us on 1300 11 43 57 or email [support@residentiagroup.com.au](mailto:support@residentiagroup.com.au)

### Power Failure

Most power failures are corrected within a few hours and should not affect the temperature of your appliance if you minimise the number of times the door is opened. If the power is going to be off for a longer period of time, take proper steps to protect the contents.

### Levelling the Unit

The appliance has 2 adjustable legs and 2 directional wheels. (Fig. 3)

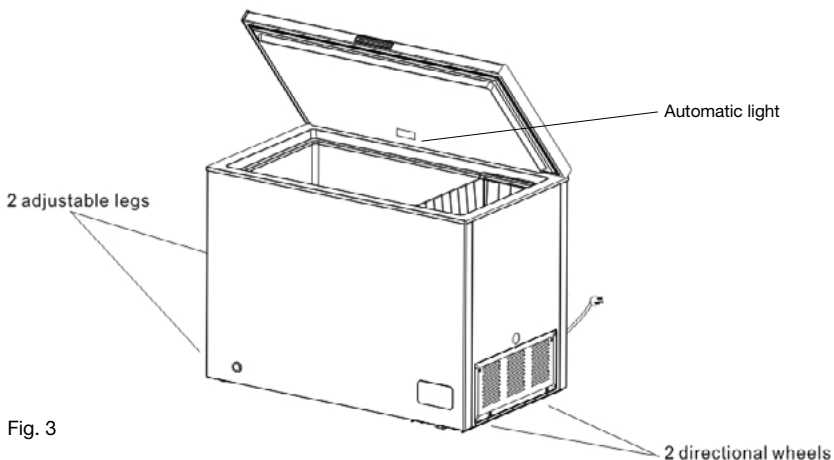

Fig. 3

To adjust the height of the legs:

- Turn the adjustable leg clockwise to raise the chest freezer. (Fig. 4)
- Turn the adjustable leg anti-clockwise to lower the chest freezer. (Fig. 4)

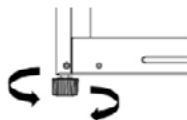

Fig. 4

## FAQs & Troubleshooting

Problem	Possible Cause	Possible Solution
The appliance does not operate.	<ul style="list-style-type: none"> <li>The appliance is not plugged in.</li> <li>The appliance is turned off.</li> <li>The circuit breaker tripped or a blown fuse.</li> </ul>	<ul style="list-style-type: none"> <li>Plug in the appliance.</li> <li>Turn on power point.</li> <li>Reset circuit breaker/replace fuse.</li> </ul>
The appliance is not cold enough.	<ul style="list-style-type: none"> <li>Check the temperature control setting.</li> <li>The door is opened too often, or is kept open for too long; the door is not closed completely; hot food has been placed inside.</li> <li>The appliance has recently been disconnected for a period of time.</li> </ul>	<ul style="list-style-type: none"> <li>Reduce the temperature.</li> <li>Do not open door for 2+ hours; Check that the door is closed properly and for any obstructions preventing the door closing properly; Remove hot food and let it cool first before replacing it.</li> <li>Plug in the appliance.</li> </ul>
The appliance has an odd odour.	<ul style="list-style-type: none"> <li>Food may not be wrapped properly.</li> <li>Food may be rotten.</li> <li>The interior may not be clean.</li> </ul>	<ul style="list-style-type: none"> <li>Check that the food is wrapped tightly.</li> <li>Check for rotten food and remove.</li> <li>Clean the interior of the appliance.</li> </ul>
The internal light does not illuminate.	<ul style="list-style-type: none"> <li>The appliance is not plugged in.</li> <li>The appliance is turned off.</li> <li>The circuit breaker tripped or a blown fuse.</li> <li>The light is damaged.</li> </ul>	<ul style="list-style-type: none"> <li>Plug in the appliance.</li> <li>Turn on power point.</li> <li>Reset circuit breaker/replace fuse.</li> <li>Please contact after sales support.</li> </ul>
The door will not close properly.	<ul style="list-style-type: none"> <li>The appliance is not level.</li> <li>The gasket is dirty.</li> <li>Food is stacked too high.</li> </ul>	<ul style="list-style-type: none"> <li>Level the appliance.</li> <li>Clean gasket with warm water and a soft cloth.</li> <li>Re-position food so it does not obstruct.</li> </ul>
The door is difficult to open.	<ul style="list-style-type: none"> <li>A difference in pressure between the air inside and outside of the unit.</li> </ul>	<ul style="list-style-type: none"> <li>This is a normal phenomenon and cannot be avoided.</li> </ul>
Moisture forms on the inside freezer walls.	<ul style="list-style-type: none"> <li>Hot and humid weather increases the internal rate of frost build-up.</li> <li>The lid is slightly open.</li> <li>The lid is kept open too long, or is opened too frequently.</li> </ul>	<ul style="list-style-type: none"> <li>This is normal.</li> <li>Close the lid.</li> <li>Open the lid less often</li> </ul>
Moisture forms on the outside of the appliance.	<ul style="list-style-type: none"> <li>The lid is slightly open, causing cold air from inside the freezer to meet warm, moist air from the outside.</li> </ul>	<ul style="list-style-type: none"> <li>Close the lid or check for obstructions.</li> </ul>
There are vibrations.	<ul style="list-style-type: none"> <li>The appliance is not level.</li> <li>The floor is uneven or weak.</li> <li>The freezer is touching the wall.</li> </ul>	<ul style="list-style-type: none"> <li>Level the appliance.</li> <li>Be sure your floor can adequately support the freezer.</li> <li>Move the appliance away from the wall and check it is level.</li> </ul>





# Specifications



	ECF142WE	ECF198WE
<b>Dimensions (mm):</b>	730W x 523D x 850H	945W x 523D x 850H
<b>Weight</b>	27kg	35kg
<b>Gross Capacity:</b>	142L	198L
<b>Other Features:</b>	Electronic thermostat control (not mechanical), Fridge/freezer interchangeable, High temperature alarm, Quick Freeze function, Anti-condensation technology, Silent hinge, Removable wire storage basket, Automatic interior LED lighting, Defrost drain system, Digital temperature control	
<b>Energy Rating:</b>	3.5 Stars MEPS	

## Standards

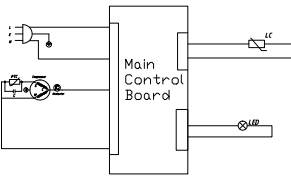
This product complies with AS/NZS 60335.1 and AS/NZS 60335.2.24 electrical safety, and with EN 55014-1:2006+A1:2009 A2:2011 for electromagnetic compatibility.

## Rating Label

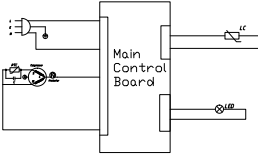
<b>Esatto</b>		142L White Hybrid Chest Fridge/Freezer	Model: ECF142WE
Climate Class	T	<b>Electric Diagram</b> 	
Protection Against Electric Shock	I		
Rated Voltage/Frequency	220-240V~/50Hz		
Rated Current	0.5A		
Foaming Agent	Cyclopentane		
Total Storage Volume	142L		
Refrigerant, Amount	R600a, 46g		
Freezing Capacity	6.5kg/24h		
Exactly what you need www.esatto.house	Support: 1300 11 4357 support@residentiagroup.com.au		 E2447

<b>Esatto</b>		<b>Chest Freezer</b> MODEL: ECF198WE	 E2447		
Climate Class	T	<b>ELECTRIC DIAGRAM</b> 			
Classification Of Protection Against Electric Shock	I				
Rated Voltage	220-240V~				
Rated Frequency	50Hz				
Rated Current	0.45A				
Energy Consumption	260kW/h/y				
Refrigerant	R600a				
Amount	56g				
Total Gross Volume	198L				
Freezer Storage Volume	198L				
Insulation Blowing Agent	Cyclopentane				
Net Weight	33kg				
Compressor	HDL125A				
Approval NO:	SGS-160614-EA			 Caution: Risk of fire	

# Warranty Information

## WARRANTY TERMS & CONDITIONS REFRIGERATION APPLIANCES

This document sets out the terms and conditions of the product warranties for Residentia Group Appliances. It is an important document. Please keep it with your proof of purchase documents in a safe place for future reference should you require service for your Appliance.

1. **IN THIS WARRANTY**
  - (a) 'acceptable quality' as referred to in clause 10 of this warranty has the same meaning referred to in the ACL;
  - (b) 'ACL' means Trade Practices Amendment (Australian Consumer Law) Act (No.2) 2010;
  - (c) 'Appliance' means any Residentia Group product purchased by you accompanied by this document;
  - (d) 'ASR' means Residentia Group authorised service representative;
  - (e) 'Residentia Group' means Residentia Group Pty Ltd of 118 Campbell St, Collingwood VIC, ACN 600 546 656 in respect of Appliances purchased in Australia;
  - (f) 'major failure' as referred to in clause 10 of this warranty has the same meaning referred to in the ACL and includes a situation when an Appliance cannot be repaired or it is uneconomic for Residentia Group, at its discretion, to repair an Appliance during the Warranty Period;
  - (g) 'Warranty Period' means:
    - (i) where the Appliance is used for personal, domestic or household use (i.e. normal single family use) as set out in the instruction manual, the Appliance is warranted against manufacturing defects for 24 months, following the date of original purchase of the Appliance;
  - (h) 'you' means the purchaser of the Appliance not having purchased the Appliance for re-sale, and 'your' has a corresponding meaning.
2. This warranty only applies to Appliances purchased and used in Australia and is in addition to (and does not exclude, restrict, or modify in any way) any non-excludable statutory warranties in Australia.
3. During the Warranty Period Residentia Group or its ASR will, at no extra charge if your Appliance is readily accessible for service, without special equipment and subject to these terms and conditions, repair or replace any parts which it considers to be defective. Residentia Group or its ASR may use remanufactured parts to repair your Appliance. You agree that any replaced Appliances or parts become the property of Residentia Group. This warranty does not apply to light globes, batteries, filters or similar perishable parts.
4. Parts and Appliances not supplied by Residentia Group are not covered by this warranty.

- 
5. You will bear the cost of transportation, travel and delivery of the Appliance to and from Residientia Group or its ASR. If you reside outside of the service area, you will bear the cost of:
- travel of an authorised representative;
  - transportation and delivery of the Appliance to and from Residientia Group or its ASR, in all instances, unless the Appliance is transported by Residientia Group or its ASR, the Appliance is transported at the owner's cost and risk while in transit to and from Residientia Group or its ASR.
6. Proof of purchase is required before you can make a claim under this warranty.
7. You may not make a claim under this warranty unless the defect claimed is due to faulty or defective parts or workmanship. Residientia Group is not liable in the following situations (which are not exhaustive):
- the Appliance is damaged by:
    - accident
    - misuse or abuse, including failure to properly maintain or service
    - normal wear and tear
    - power surges, electrical storm damage or incorrect power supply
    - incomplete or improper installation
    - incorrect, improper or inappropriate operation
    - insect or vermin infestation
    - failure to comply with any additional instructions supplied with the Appliance;
  - the Appliance is modified without authority from Residientia Group in writing;
  - the Appliance's serial number or warranty seal has been removed or defaced;
  - the Appliance was serviced or repaired by anyone other than Residientia Group, an authorised repairer or ASR.
8. This warranty, the contract to which it relates and the relationship between you and Residientia Group are governed by the law applicable where the Appliance was purchased.
9. To the extent permitted by law, Residientia Group excludes all warranties and liabilities (other than as contained in this document) including liability for any loss or damage whether direct or indirect arising from your purchase, use or non use of the Appliance.
10. For Appliances and services provided by Residientia Group in Australia, the Appliances come with a guarantee by Residientia Group that cannot be excluded under the Australian Consumer Law. You are entitled to a replacement or refund for a major failure and for compensation for any other reasonably foreseeable loss or damage. You are also entitled to have the Appliance repaired or replaced if the Appliance fails to be of acceptable quality and the failure does not amount to a major failure. The benefits to you given by this warranty are in addition to your other rights and remedies under a law in relation to the Appliances or services to which the warranty relates.
11. At all times during the Warranty Period, Residientia Group shall, at its discretion, determine whether repair, replacement or refund will apply if an Appliance has a valid warranty claim applicable to it.
12. To enquire about claiming under this warranty, please follow these steps:
- carefully check the operating instructions, user manual and the terms of this warranty;
  - have the model and serial number of the Appliance available;
  - have the proof of purchase (e.g. an invoice) available;
  - telephone the numbers shown below.
13. You accept that if you make a warranty claim, Residientia Group and its ASR may exchange information in relation to you to enable Residientia Group to meet its obligations under this warranty.

**IMPORTANT**

Before calling for service, please ensure that the steps in point 12 have been followed.

## Telephone contacts

- Service: Please call 1300 11 HELP (4357)  
 → Spare Parts: Please call 1300 11 SPARE (7727)



E2447

# Esatto Appliances Exactly what you need



A RESIDENTIA  
GROUP INITIATIVE